

Lightning and surge protection for free field PV power plants

White Paper



Contents

Measures for protecting PV power plants from lightning interference:

- Air-termination system and down conductors
- Earth-termination system
- Lightning equipotential bonding
- Lightning protection system
- Cable routing
- Surge protection measures
- Special surge protective devices for PV systems
- Decentralised string inverters
- Information technology systems

Lightning and surge protection for free field PV power plants

White Paper



With a newly installed capacity of some gigawatts annually, free field PV power plants are becoming an integral part of modern power supply systems in many countries. Today large-scale power plants with a capacity of 100 MW and higher are installed which are directly connected to the medium and high-voltage level. As an integral part of a power supply system, photovoltaic systems must ensure stable grid operation. In addition, any production downtimes are recorded by the yield monitoring system. These have a negative impact on the annual performance ratio of the plant. Consequently, the investment volume and a minimum service life requirement of 20 years make it necessary to assess the risk of damage by lightning and take appropriate protection measures.

Risk of a lightning strike to structures such as PV power plants

There is a connection between solar radiation, air humidity and the frequency of lightning discharges. Regions with high solar radiation and air humidity are more susceptible to lightning strikes. The regional lightning frequency (lightning strikes per square kilometres/year) and the location and size of the PV power plant form the basis for calculating the probability of lightning strikes to the plant. PV systems are exposed to local weather conditions such as thunderstorms over decades.

Necessity of lightning and surge protection

Damage to PV systems is caused both by the destructive effects of a direct lightning strike and inductive or capacitive coupling of voltages caused by the electromagnetic lightning field. Moreover, voltage peaks resulting from switching operations on the upstream AC system can cause damage to PV modules, inverters, charge controllers and their monitoring and communication systems.

The economic damage comprises replacement and repair costs and loss of yield culminating in the cost of drawing power from reserve power plants. Lightning impulses also cause premature ageing of bypass diodes, power semiconductors and the input and output circuits of data systems, which leads to increased repair costs.

In addition, network operators have expectations with regard to the availability of the energy generated. These are usually stipulated in the applicable Grid Code. Such considerations are becoming increasingly important in terms of financing and insurance. Due diligence tests for financing now look at lightning protection measures. Section 8 of IEC 61643-32 calls for the installation of surge protective devices unless a risk analysis demonstrates that SPDs are not required.

The risk resulting from a lightning strike must be determined according to the IEC 62305-2 standard and the results of this risk analysis must be considered at the design stage. For this purpose, DEHN offers the DEHNsupport software. A risk analysis performed by means of this software ensures a technically and economically optimised lightning protection concept which is understood by all parties involved and offers the necessary protection at reasonable costs.

Measures for protecting PV power plants from lightning interference

To ensure effective protection, a lightning protection system with optimally coordinated elements (air-termination system, earth-termination system, lightning equipotential bonding, surge protective devices for power supply and data systems) is required.

Air-termination system and down conductors

To prevent direct lightning strikes to the electrical systems of a PV power plant, these systems must be located in the protected volume of air-termination systems. Design according to IEC TR 63277 ** is normally based on class of LPS III. According to this class of LPS, the rolling sphere method (Figure 1) as per IEC 62305-3 can be used to determine the number of air-termination rods. These air-termination rods form a protected volume above module racks, operations buildings and cables. Due to the inductive coupling of interference, it is advisable to install generator junction boxes mounted on module racks and decentralised inverters as far away as possible from air-termination systems. The high masts on which CCTV systems are installed also act as air-termination systems. The CCTV system itself must be mounted in such a way that it is located in the protected volume of the mast. All down conductors of these air-termination systems must be connected to the terminal lugs of the earth-termination system. Terminal lugs must be corrosion-resistant (stainless steel (V4A), e.g. material no. AISI/ASTM 316 Ti) due to the risk of corrosion at the point where they leave the soil or concrete. Terminal lugs made of galvanised steel must be protected by adequate measures, e.g. Denso tape or heat shrinkable sleeves.

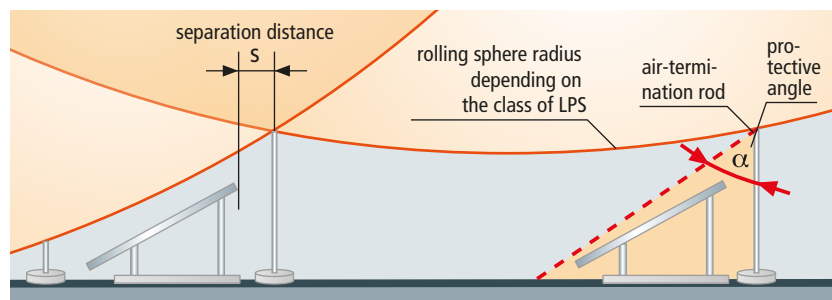

Figure 1 Rolling sphere method vs. protective angle method for determining the protected volume

Lightning and surge protection for free field PV power plants

White Paper



Figure 2 Lightning protection by means of DEHNiso spacers

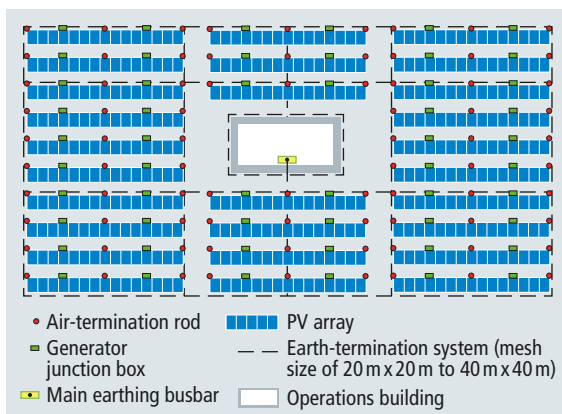

Figure 3 Earth-termination system as per IEC TR 63227

To mechanically fix the air-termination systems in place, they can frequently be connected to the module racks. Angled air-termination tips, for example, are suitable for this purpose (Figure 2).

Earth-termination system

An earth-termination system (Figure 3) forms the basis for implementing effective lightning and surge protection measures in PV power plants. In Annex D of IEC TR 63277, an earth resistance R_A of less than 10Ω is recommended for an earth-termination system. A meshed 10 mm stainless steel wire (20 m x 20 m to 40 m x 40 m) buried below the frost

line is durable and has proven its worth in practice. The metal module racks can be used as part of the mesh if they fulfil the requirements of the IEC 62305-3 standard. IEC TR 63227 recommends that metal racks be interconnected. The mesh is frequently installed in the existing cable trenches and should be closed. The EN 61936-1 and EN 50522 standards must be particularly observed for the earth-termination systems of the operations buildings. The earth-termination systems of the PV generators and the operations buildings must be interconnected by means of a flat strip (30 mm x 3.5 mm) or a round wire (\varnothing 10 mm) (stainless steel (V4A), e.g. material no. AISI/ASTM 316 Ti, or copper or galvanised steel). This interconnection of the individual earth-termination systems reduces the total earth resistance. By intermeshing the earth-termination systems, an equipotential surface is created which considerably reduces the voltage stress on the electrical connecting lines in case of lightning interference between the PV array and the operations building. Influencing factors like corrosion, soil moisture and frost must be taken into account in order to keep the earth resistance stable over the many years in which a PV power plant operates. Only the areas below the frost line count towards the effective length of the earth electrode. The meshes must be interconnected via adequate lightning-current-tested connection components. The metal mounting systems on which the PV modules are installed must be connected to each other and to the earth-termination system. Mounting systems with a pile-driven or screw-in foundation can be used as earth electrodes (Figure 4) if they have the material and wall thickness specified in Table 7 of the IEC 62305-3 standard. The required minimum length of 2.5 m in the area below the frost line can be added together in case of individual interconnected lightning-current-proof elements. These foundations must be interconnected in such a way that they can carry lightning currents, for example, by means of an 8 mm stainless steel wire (e.g. material no. AISI/ASTM 316 Ti) and a UNI saddle clamp (Figure 5).

Lightning equipotential bonding

Lightning equipotential bonding means directly connecting all metal systems in such a way that they can carry lightning currents. If the modules, cables and the operations building with weather station are located in the protected volume of the external lightning protection system, direct lightning currents on the lines are not to be expected. If the connection to the distribution network operator (DNO) is established on the low-voltage level, this point is connected to the main earthing busbar (MEB) via type 1 lightning current arresters (e.g. DEHNventil) since partial lightning currents are present. The same applies to the incoming telecommunication cables for which type 1 arresters such as BLITZDUCTOR or DEHN-box (Figure 6) must be installed.

Lightning and surge protection for free field PV power plants

White Paper

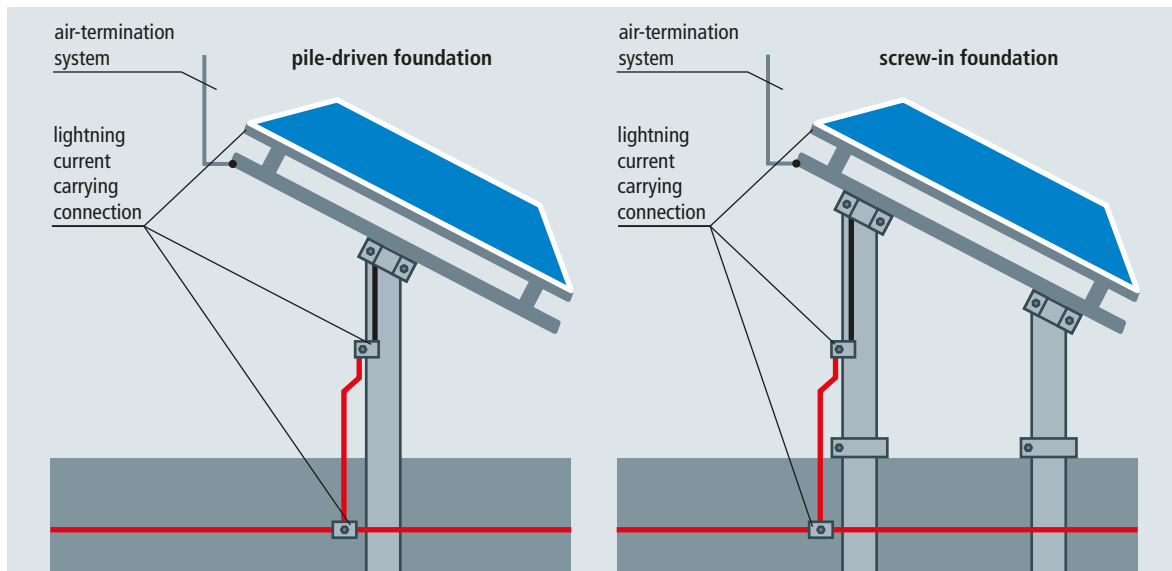

Figure 4 Pile-driven and screw-in foundation with a lightning current carrying connection between the air-termination system and the earth-termination system

Solar generator and external lightning protection system

The air-termination systems of the external lightning protection system are paramount. In case of an uncontrolled lightning strike to the PV system, lightning currents will flow into the electrical installation and cause severe damage to the system. When installing the external lightning protection system, it must be ensured that solar cells are not shaded, for example, by air-termination rods. Diffuse shadows, which occur in case of distant rods or conductors, do not negatively affect the PV system and the yield. Core shadows, however, unnecessarily stress the cells and the associated bypass diodes. The required distance can be calculated and depends on the diameter of the air-termination rod. For example, if an air-termination rod with a diameter of 10 mm shades a module, only a diffuse shadow is cast on the module if a distance of 1.08 m is maintained between the module and the air-termination rod. Annex A of the IEC TR 63277 standard provides more detailed information on the calculation of core shadows.

Cable routing in PV systems

All cables must be routed in such a way that large conductor loops are avoided. This applies to for the single-pole series connections of the DC circuits (string) and to several interconnected strings. Moreover, data or sensor lines must not be routed across several strings and form large conductor loops with the string lines. For this reason, power (DC and AC), data and equipotential bonding conductors must be routed together as far as practicable.

Surge protection measures for PV power plants

Surge protective devices (SPDs) (Figure 6) must be installed to protect the electrical systems in PV power plants. In case of a lightning strike to the external lightning protection system of a free field PV system, high voltage impulses are induced on all electrical conductors and partial lightning currents flow into all sorts of park cables (DC, AC and data cables). The magnitude of the partial lightning currents depends on, for example, the type of earth-termination system, soil resistivity on site and the type of cables. In case of power plants with central inverters (Figure 6), extended DC cables are routed in the field. Table A.3 of the IEC 61643-32 standard and IEC TR 63227 require a minimum discharge capacity I_{total} of 10 kA (10/350 μ s) for voltage-limiting type 1 DC SPDs. SPDs with a maximum short-circuit current rating I_{SCPV} , which is determined by means of the EN 50539-11 standard and



Figure 5 UNI saddle clamp

Lightning and surge protection for free field PV power plants

White Paper

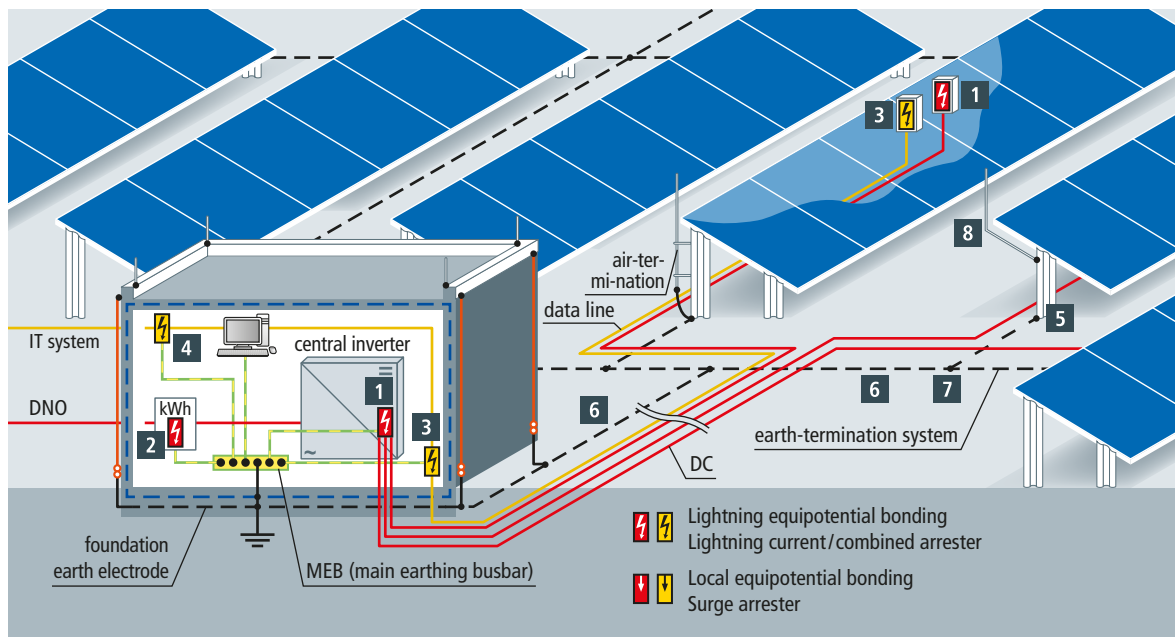

		SPD	* FM = Floating remote signalling contact	Part No.
DC input of the inverter				
1	Central inverter + GJB	DEHNcombo DCB YPV 1200 FM*		900 075
		DEHNcombo DCB YPV 1500 FM*		900 076
AC side of the grid connection				
2	TN-C system	DEHNventil DV M2 TNC 255 FM*		954 305
	TN-S system	DEHNventil DV M2 TNS 255 FM*		954 405
	TT system	DEHNventil DV M2 TT 255 FM*		954 315
Data interface				
3	One pair, up to 5 V	BLITZDUCTORconnect ML2 BD HF 5		927 271
Remote maintenance				
4	ISDN/DSL	DEHNbox DBX TC B 180		922 220
Earth-termination system				
5	Equipotential bonding	UNI saddle clamp		365 250
6	Earthing conductor	Round wire (Ø 10 mm) St/tZn		800 310
		Round wire (Ø 10 mm) StSt (V4A)		860 010
		Strip steel (30 x 3.5 mm) St/tZn		852 335
		Strip steel (30 x 3.5 mm) StSt (V4A)		860 325
7	Connection element	MV clamp StSt (V4A)		390 079
		alternative: SV clamp St/tZn		308 220
8	Air-termination system	Angled air-termination tip (including two saddle clamps)		101 110

Figure 6 Lightning protection concept for a PV power plant with central inverter

Lightning and surge protection for free field PV power plants

White Paper

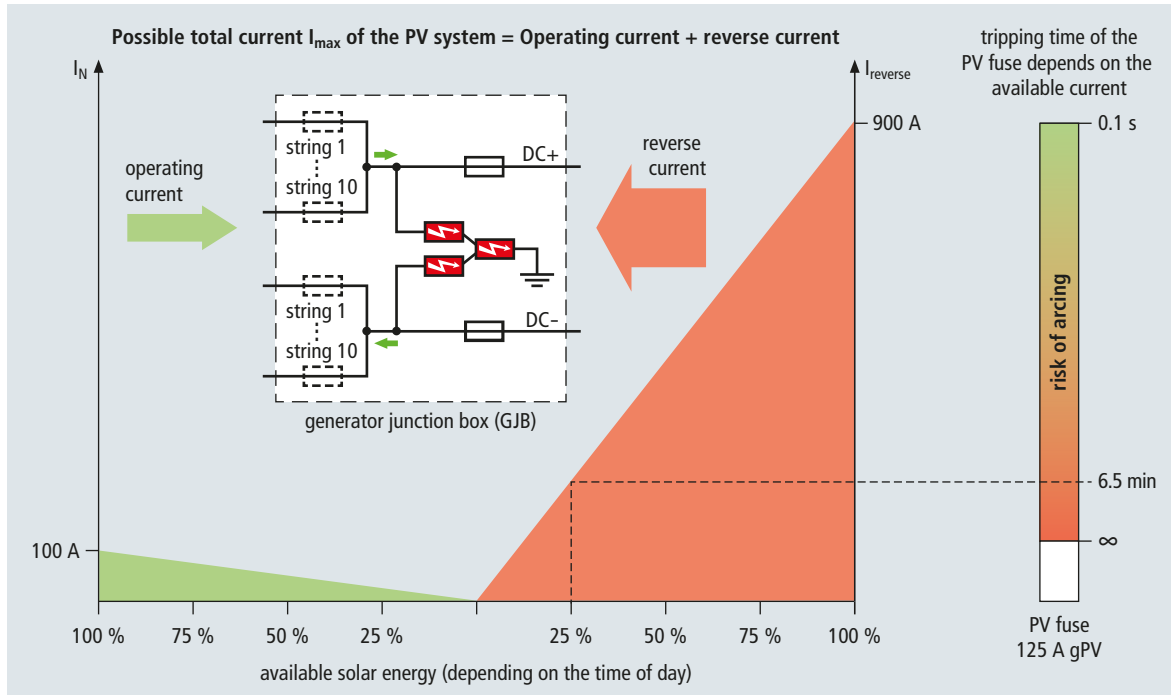

Figure 7 PV system with I_{max} of 1000 A: Prospective short-circuit current at the PV arrester depending on the time of day

must be specified by the manufacturer, must be used. This also applies to possible reverse currents.

In PV systems with central inverters, fuses protect against reverse currents. The maximum available current depends on the actual solar radiation. In certain operating states, fuses only trip after some minutes (Figure 7). Therefore, surge protective devices installed in generator junction boxes must be designed for the possible total current consisting of the operating current and the reverse current and ensure automatic disconnection without arcing in case of overload ($I_{SCP} > I_{max}$ of the PV system).

Special surge protective devices for the DC side of PV systems

The typical U/I characteristic curves of photovoltaic current sources are very different from those of conventional DC sources: They have a non-linear characteristic (Figure 8) and very different DC arc behaviour. This trait not only affects the design and size of PV DC switches and PV fuses, but also requires the surge protective devices used to be adapted to it and to be capable of coping with PV DC follow currents.

The IEC 61643-32 and IEC TR 63277 standards include a detailed assessment of the lightning current distribution (computer simulations). To calculate the lightning current distribution, the down conductors of the lightning protection system,

possible earth connections of the PV array and the DC lines must be considered. It is shown that the magnitude and amplitude of the partial lightning currents flowing via the SPDs into the DC lines not only depend on the number of down conductors, but are also influenced by the impedance of the SPDs. In turn, the impedance of the SPDs depends on the rated

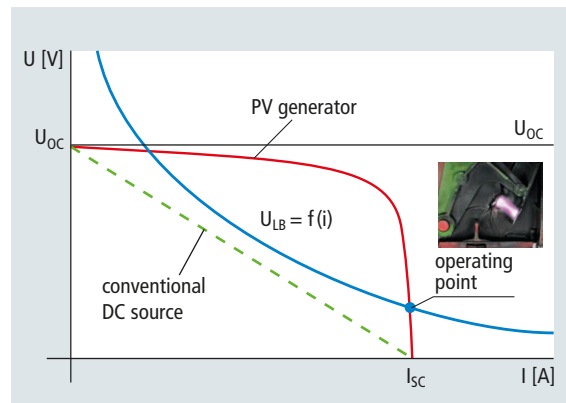

Figure 8 Source characteristic of a conventional DC source versus the source characteristic of a PV generator. When switching PV sources, the source characteristic of the PV generator crosses the arc voltage range.

Lightning and surge protection for free field PV power plants

White Paper



Class of LPS and maximum lightning current (10/350 μ s)		Values for voltage-limiting or combined type 1 SPDs (series connection)			
		$I_{10/350}$		$I_{8/20}$	
		Per protective path [kA]	I_{total} [kA]	Per protective path [kA]	I_{total} [kA]
III and IV	100 kA	5	10	15	30

Table 1 Minimum discharge capacity of voltage-limiting or combined type 1 SPDs for free field PV systems in case of LPL III; according to Table A.3 of the IEC 61643-32 standard and also IEC TR 63227

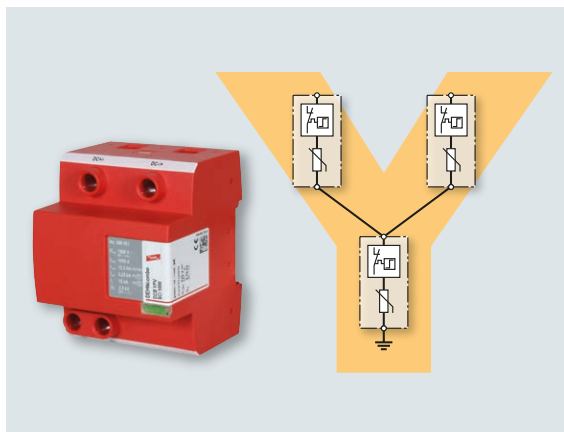

Figure 9 DEHNCombo YPV type 1 + type 2 combined arrester with fault-resistant Y circuit

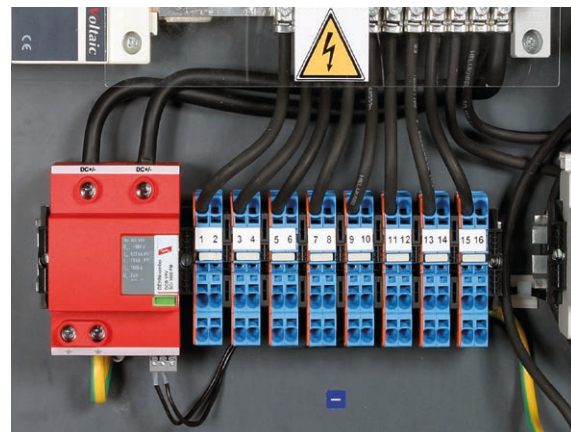

Figure 10 Surge protective device in a monitoring generator junction box

voltage of the SPDs, the SPD topology and the type of SPD (voltage-switching or voltage-limiting). The reduction of the impulse form is characteristic of partial lightning currents flowing via SPDs on the DC side of the PV system. When selecting adequate surge protective devices, both the maximum impulse current and the impulse load must be considered.

To facilitate the selection of adequate arresters, **Table 1** shows the required lightning impulse current carrying capability I_{imp} of type 1 SPDs. The maximum impulse currents and partial lightning currents of 10/350 μ s wave form are considered to ensure that the SPDs are capable of discharging the impulse load of the lightning currents.

With its proven fault-resistant Y circuit, DEHNCombo YPV (FM) fulfils the requirements mentioned above (**Figure 9**).

DEHNCombo YPV ... (FM), which can be installed at the inverter or in the generator junction box, allows you to protect PV generators with a capacity up to 10,000 A without an additional backup fuse (**Figure 10**). DEHNCombo YPV is available for system voltages ≤ 1200 V and ≤ 1500 V.

If string monitoring is used, the floating remote signalling contacts which are used to monitor the status of the SPDs can be integrated in these monitoring systems.

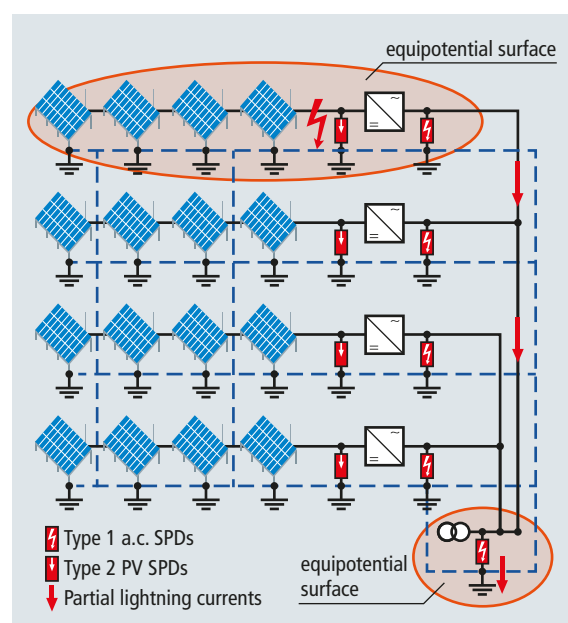
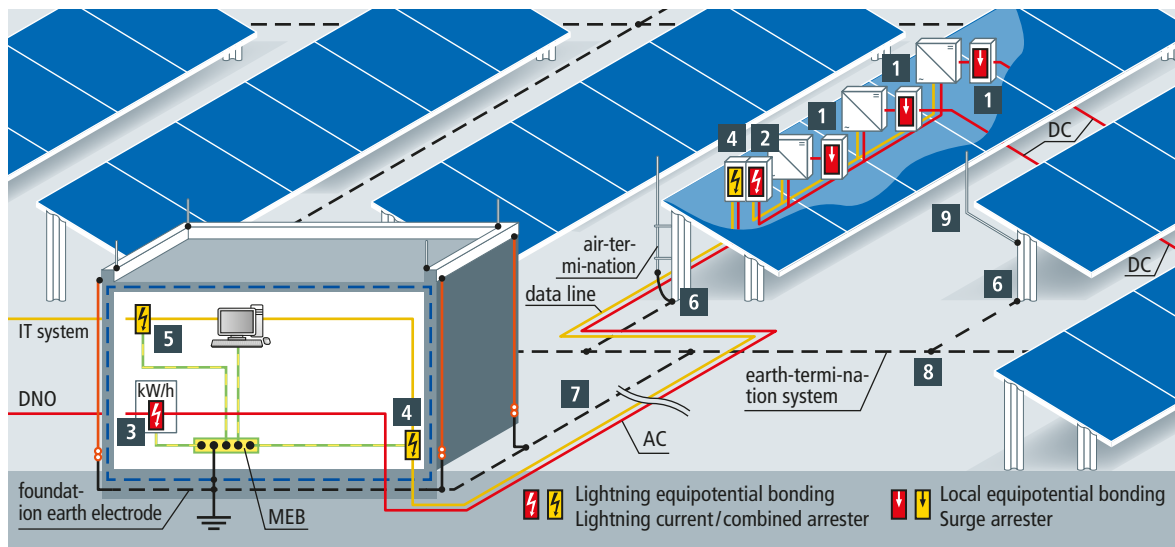

Figure 11 Lightning current distribution in case of free field PV systems with string inverters

Lightning and surge protection for free field PV power plants

White Paper



		SPD	* FM = Floating remote signalling contact	Part No.
DC input of the inverter				
1	UCPV ≤ 1170 V	DEHNguard M YPV 1200 FM*		952 565
	UCPV ≤ 1500 V	DEHNguard M YPV 1500 FM*		952 567
AC side of the inverter				
2	TN-S system	DEHNshield DSH TNS 255 FM*		941 405
AC side of the grid connection				
3	TN-C system	DEHNventil DV M2 TNC 255 FM*		954 305
	TN-S system	DEHNventil DV M2 TNS 255 FM*		954 405
	TT system	DEHNventil DV M2 TT 255 FM*		954 315
Data interface				
4	One pair, up to 5 V	BLITZDUCTORconnect ML2 BD HF 5		927 271
Remote maintenance				
5	ISDN/DSL	DEHNbox DBX TC B 180		922 220
Earth-termination system / external lightning protection system				
6	Equipotential bonding	UNI saddle clamp		365 250
7	Earthing conductor	Round wire (Ø 10 mm) St/tZn		800 310
		Round wire (Ø 10 mm) StSt (V4A)		860 010
		Strip steel (30 x 3.5 mm) St/tZn		852 335
		Strip steel (30 x 3.5 mm) StSt (V4A)		860 325
8	Connection element	MV clamp StSt (V4A)		390 079
		alternative: SV clamp St/tZn		308 220
9	Air-termination system	Angled air-termination tip (including 2 saddle clamps)		101 110

Figure 12 Lightning protection concept for a PV power plant with string inverters

Lightning and surge protection for free field PV power plants

White Paper



PV power plants with decentralised string inverters

If PV power plants with decentralised string inverters are used, most of the power cables are installed on the AC side. The inverters are installed in the field underneath the module racks of the relevant solar generators. Due to the proximity to the modules, the inverter assumes typical functions of generator junction boxes.

IEC 61643-32 and IEC TR 63227 describe how the lightning current distribution is influenced by the power cables (string or central inverter). **Figure 11** demonstrates the lightning current distribution in case of string inverters. If string inverters are installed, the power cables are also used as an equipotential bonding conductor between the local earth potential of the PV array hit by lightning and the remote equipotential surface of the infeed transformer. The only difference to plants with central inverters is that in case of PV systems with string inverters the partial lightning currents flow into the AC lines. Therefore, type 1 arresters are installed on the AC side of the string inverters and on the low-voltage side of the infeed transformer. **Table 1** shows the minimum discharge capacity of type 1 SPDs depending on the SPD technology. Type 2 SPDs such as DEHNguard M YPV 1500 FM are sufficient for the DC side of string inverters. This arrester is available in two types: For system voltages ≤ 1170 V and ≤ 1500 V. If an earth-termination system according to IEC TR 63277 is installed, the string inverters and the PV array connected to them form a local equipotential surface so that injection of lightning current is not expected in the DC lines since the arresters largely limit induced interference. In this way, they also protect nearby modules from surges. Several AC outputs of these outdoor inverters are collected and stored in AC boxes. If type 1 arresters such as DEHNshield...255 (FM) are installed there, these devices protect all inverter outputs up to a distance of 10 m (conducted). Further AC field cables are routed into the operations building where the powerful type 1 and type 2 DEHNventil combined arrester protects the electrical equipment for the grid connection point. Other equipment such as the grid and plant protection, alarm panel or web server which is located less than 10 m (conducted) from this SPD is also protected (**Figure 12**).

Surge protection measures for information technology systems

Data from the field as well as data acquired from remote maintenance by the plant operator and capacity measurements and control by the grid operator are collected in operations buildings. To ensure that the service staff is able to specifically determine causes of failure via remote diagnostics and eliminate them on site, reliable data transfer must be safeguarded at all times. The string and inverter monitoring system, weather data acquisition unit, anti-theft protection and external communication system are based on different physical interfaces.

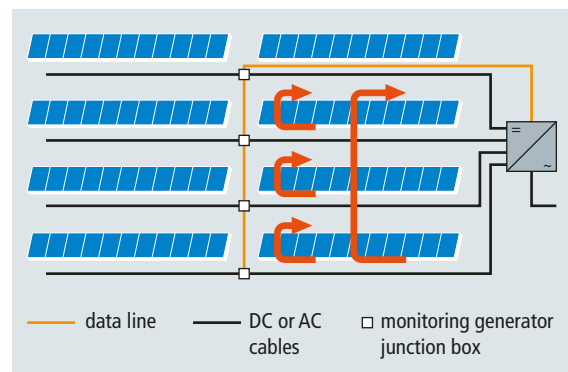

Figure 13 Basic principle of induction loops in PV power plants

Wind and radiation sensors with analogue signal transmission can be protected by DEHNbox DBX. Thanks to its actiVsense technology, DEHNbox DBX can be used for signal voltages up to 180 V and automatically adapts the voltage protection level. BLITZDUCTOR is ideal for protecting any RS 485 communication interfaces used between the inverters. DEHNgate BNC VC devices are used to protect CCTV systems with coaxial video transmission of the type used in anti-theft protection systems. If the sub-stations of large-scale PV power plants are interconnected via Ethernet, DEHNpatch, which can be used for PoE (Power over Ethernet) applications up to 10 Gbit/Class E_A, can be installed. No matter if it is an ISDN or ADSL connection – the data lines of devices which provide a connection to the outside world are also protected by the relevant surge protective devices.

In case of power plants with central inverters, generator junction boxes with additional measuring sensors are installed in the field. In case of power plants with string inverters (**Figure 12**), their integrated string monitoring system takes over this task. In both cases, the measured values from the field are transmitted via data interfaces. The data lines from the service room are installed together with the power cables (AC or DC). Due to the short line lengths of field bus systems, data cables are individually routed transversely to the module racks. In case of a direct lightning strike, these transverse connections also carry partial lightning currents which may damage the input circuits and cause flashover to power cables. Large induction loops are formed due to the interaction of power cables, rows of metal module racks data lines (**Figure 13**). This is an ideal environment for transients caused by lightning discharges which can be injected into these lines. Such voltage peaks are capable of exceeding the insulation strength/dielectric strength of these systems which leads to surge damage. Therefore, SPDs must be installed in these monitoring generator junction boxes or in the decentralised

Lightning and surge protection for free field PV power plants

White Paper



string inverters to protect data transmission. Cable shields must be connected to all connection points in line with the EN 50174-2 standard. This can also be achieved by indirect shield earthing to prevent malfunctions such as ripples and stray currents.

Consistent lightning and surge protection for all systems considerably increases the performance ratio of these power plants. The service and maintenance time as well as repair and

spare part costs are reduced, thus increasing the value of the PV system.

** IEC TR 63227 ED1 „Lightning and surge voltage protection for photovoltaic (PV) power supply systems“ has been approved by TC 82 „Solar photovoltaic energy systems“ and will be published within 2019.

DEHNventil

DV M2 TNC 255 FM (954 305)

- Prewired type 1, type 2 and type 3 spark-gap-based combined arrester consisting of a base part and plug-in protection modules
- Compact unit meets maximum safety requirements thanks to Rapid Arc Control (RAC)
- Capable of protecting terminal equipment



Figure without obligation

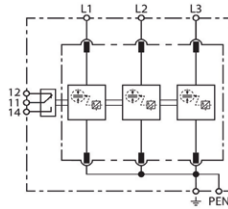

Basic circuit diagram DV M2 TNC 255 FM

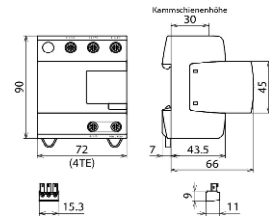

Dimension drawing DV M2 TNC 255 FM

Modular combined lightning current and surge arrester for TN-C systems.

Type Part No.	DV M2 TNC 255 FM 954 305
SPD according to EN 61643-11 / IEC 61643-11	type 1 + type 2 + type 3 / class I + class II + class III
Nominal voltage (a.c.) (U_N)	230 / 400 V (50 / 60 Hz)
Max. continuous operating voltage (a.c.) (U_C)	255 V (50 / 60 Hz)
Lightning impulse current (10/350 μ s) [L-PEN] (I_{imp})	25 kA
Specific energy [L-PEN] (W/R)	156.25 kJ/ohms
Nominal discharge current (8/20 μ s) [L-PEN] (I_n)	25 kA
Voltage protection level (U_p)	≤ 1.5 kV
Open-circuit voltage of the combination wave generator (U_{oc})	6 kV
Follow current extinguishing capability (a.c.) (I_n)	50 kA _{rms}
Follow current limitation / Selectivity	No tripping of a 32 A gG fuse up to 50 kA _{rms} (prosp.)
Short-circuit current rating [L-N]/[N-PE] (I_{SCCR})	50 kA _{rms}
Response time (t_A)	≤ 100 ns
Max. backup fuse (L) up to $I_k = 50$ kA _{rms}	250 A gG
Temporary overvoltage (TOV) (U_T) – Characteristic	440 V / 120 min. – withstand
Let-through energy with an S20K275 ($I_{imp} = 2.5$ to 25 kA)	< 1 J
Operating temperature range [parallel] / [series] (T_U)	-40 °C ... +80 °C / -40 °C ... +60 °C
Operating state / fault indication	green / red
Number of ports	1
Cross-sectional area (L1, L2, L3, PEN, \perp) (min.)	10 mm ² solid / flexible
Cross-sectional area (L1, L2, L3, PEN, \perp) (max.)	35 mm ² stranded / 25 mm ² flexible
For mounting on	35 mm DIN rails acc. to EN 60715
Place of installation	indoor installation
Degree of protection	IP 20
Capacity	4 module(s), DIN 43880
Approvals	VDE, KEMA, UL
Type of remote signalling contact	yes / changeover contact
Switching capacity (a.c.)	250 V / 0.5 A
Switching capacity (d.c.)	250 V / 0.1 A; 125 V / 0.2 A; 75 V / 0.5 A
Cross-sectional area for remote signalling terminals	max. 1.5 mm ² solid / flexible
For use in switchgear installations with prospective short-circuit currents of more than 50 kA _{rms} (tested by the German VDE)	-----
– Max. prospective short-circuit current	100 kA _{rms} (220 kA _{peak})
– Limitation / Extinction of mains follow currents	up to 100 kA _{rms} (220 kA _{peak})
– Max. backup fuse (L) up to $I_k = 100$ kA _{rms}	250 A gG

Use for 16.7 Hz traction power supply systems

Type Part No.	DV M2 TNC 255 FM 954 305
– Test voltage AC (U_C)	266 V
– Nominal voltage (a.c.) (U_N)	230 / 400 V
– Nominal frequency (a.c.) (f_N)	16.7 Hz
– Max. backup fuse	160 A gG @ 16,7 Hz
Weight	459 g
Customs tariff number (Comb. Nomenclature EU)	85363090
GTIN	4013364400900
PU	1 pc(s)

DEHNventil

DV M2 TT 255 FM (954 315)

- Prewired spark-gap-based type 1, type 2 and type 3 combined arrester consisting of a base part and plug-in protection modules
- Compact unit meets maximum safety requirements thanks to Rapid Arc Control (RAC)
- Capable of protecting terminal equipment



Figure without obligation

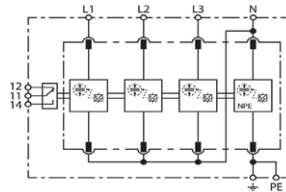

Basic circuit diagram DV M2 TT 255 FM

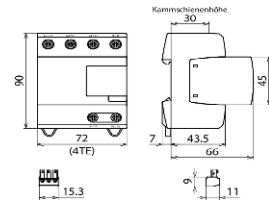

Dimension drawing DV M2 TT 255 FM

Modular combined lightning current and surge arrester for TT and TN-S systems (3+1 configuration).

Type	DV M2 TT 255 FM
Part No.	954 315
SPD according to EN 61643-11 / IEC 61643-11	type 1 + type 2 + type 3 / class I + class II + class III
Nominal voltage (a.c.) (U_N)	230 / 400 V (50 / 60 Hz)
Max. continuous operating voltage (a.c.) [L-N] (U_C)	255 V (50 / 60 Hz)
Max. continuous operating voltage (a.c.) [N-PE] ($U_{C(N-PE)}$)	255 V (50 / 60 Hz)
Lightning impulse current (10/350 μ s) [L1+L2+L3+N-PE] (I_{total})	100 kA
Specific energy [L1+L2+L3+N-PE] (W/R)	2.50 MJ/ohms
Lightning impulse current (10/350 μ s) [L-N]/[N-PE] (I_{imp})	25 / 100 kA
Specific energy [L-N]/[N-PE] (W/R)	156.25 kJ/ohms / 2.50 MJ/ohms
Nominal discharge current (8/20 μ s) [L-N]/[N-PE] (I_n)	25 / 100 kA
Voltage protection level [L-N]/[N-PE] (U_p)	≤ 1.5 / ≤ 1.5 kV
Open-circuit voltage of the combination wave generator (U_{OC})	6 kV
Follow current extinguishing capability [L-N]/[N-PE] (I_f)	50 kA _{rms} / 100 A _{rms}
Follow current limitation / Selectivity	No tripping of a 32 A gG fuse up to 50 kA _{rms} (prosp.)
Short-circuit current rating [L-N]/[N-PE] (I_{SCCR})	50 kA _{rms} / 100 A _{rms}
Response time (t_A)	≤ 100 ns
Max. backup fuse (L) up to $I_{\kappa} = 50$ kA _{rms}	250 A gG
Temporary overvoltage (TOV) [L-N] (U_T) – Characteristic	440 V / 120 min. – withstand
Temporary overvoltage (TOV) [N-PE] (U_T) – Characteristic	1200 V / 200 ms – withstand
Let-through energy with an S20K275 ($I_{imp} = 2.5$ to 25 kA)	< 1 J
Operating temperature range [parallel] / [series] (T_U)	-40 °C ... +80 °C / -40 °C ... +60 °C
Operating state / fault indication	green / red
Number of ports	1
Cross-sectional area (L1, L2, L3, N, PE, \varnothing) (min.)	10 mm ² solid / flexible
Cross-sectional area (L1, L2, L3, N, PE, \varnothing) (max.)	35 mm ² stranded / 25 mm ² flexible
For mounting on	35 mm DIN rails acc. to EN 60715
Place of installation / Degree of protection	indoors / IP 20
Capacity	4 module(s), DIN 43880
Approvals	VDE, KEMA, UL
Type of remote signalling contact	yes / changeover contact
Switching capacity (a.c.)	250 V / 0.5 A
Switching capacity (d.c.)	250 V / 0.1 A; 125 V / 0.2 A; 75 V / 0.5 A
Cross-sectional area for remote signalling terminals	max. 1.5 mm ² solid / flexible
Extended technical data:	-----
Voltage protection level [L-PE] (U_p)	1.8 kV
For use in switchgear installations with prospective short-circuit currents of more than 50 kA _{rms} (tested by the German VDE)	-----
– Max. prospective short-circuit current	100 kA _{rms} (220 kA _{peak})
– Limitation / Extinction of mains follow currents	up to 100 kA _{rms} (220 kA _{peak})
– Max. backup fuse (L) up to $I_{\kappa} = 100$ kA _{rms}	250 A gG

Use for 16.7 Hz traction power supply systems

Type	DV M2 TT 255 FM
Part No.	954 315
– Test voltage AC (U_C)	266 V
– Nominal voltage (a.c.) (U_N)	230 / 400 V
– Nominal frequency (a.c.) (f_N)	16.7 Hz
– Max. backup fuse	160 A gG @ 16,7 Hz
Weight	537 g
Customs tariff number (Comb. Nomenclature EU)	85363090
GTIN	4013364400917
PU	1 pc(s)

DEHNventil

DV M2 TNS 255 FM (954 405)

- Prewired spark-gap-based type 1, type 2 and type 3 combined arrester consisting of a base part and plug-in protection modules
- Compact unit meets maximum safety requirements thanks to Rapid Arc Control (RAC)
- Capable of protecting terminal equipment



Figure without obligation

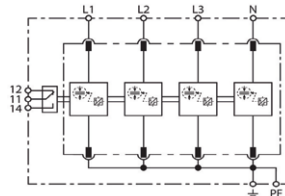

Basic circuit diagram DV M2 TNS 255 FM

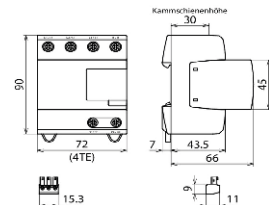

Dimension drawing DV M2 TNS 255 FM

Modular combined lightning current and surge arrester for TN-S systems.

Type	DV M2 TNS 255 FM
Part No.	954 405
SPD according to EN 61643-11 / IEC 61643-11	type 1 + type 2 + type 3 / class I + class II + class III
Nominal voltage (a.c.) (U_N)	230 / 400 V (50 / 60 Hz)
Max. continuous operating voltage (a.c.) (U_C)	255 V (50 / 60 Hz)
Lightning impulse current (10/350 μ s) [L1+L2+L3+N-PE] (I_{total})	100 kA
Specific energy [L1+L2+L3+N-PE] (W/R)	2.50 MJ/ohms
Lightning impulse current (10/350 μ s) [L, N-PE] (I_{imp})	25 kA
Specific energy [L,N-PE] (W/R)	156.25 kJ/ohms
Nominal discharge current (8/20 μ s) [L/N-PE]/[L1+L2+L3+N-PE] (I_n)	25 / 100 kA
Voltage protection level [L-PE]/[N-PE] (U_P)	$\leq 1.5 / \leq 1.5$ kV
Open-circuit voltage of the combination wave generator (U_{OC})	6 kV
Follow current extinguishing capability (a.c.) (I_e)	50 kA _{rms}
Follow current limitation / Selectivity	No tripping of a 32 A gG fuse up to 50 kA _{rms} (prosp.)
Short-circuit current rating [L-N]/[N-PE] (I_{SCCR})	50 kA _{rms}
Response time (t_A)	≤ 100 ns
Max. backup fuse (L) up to $I_k = 50$ kA _{rms}	250 A gG
Temporary overvoltage (TOV) [L-N] (U_T) – Characteristic	440 V / 120 min. – withstand
Let-through energy with an S20K275 ($I_{imp} = 2.5$ to 25 kA)	< 1 J
Operating temperature range [parallel] / [series] (T_U)	-40 °C ... +80 °C / -40 °C ... +60 °C
Operating state / fault indication	green / red
Number of ports	1
Cross-sectional area (L1, L2, L3, N, PE, \pm) (min.)	10 mm ² solid / flexible
Cross-sectional area (L1, L2, L3, N, PE, \pm) (max.)	35 mm ² stranded / 25 mm ² flexible
For mounting on	35 mm DIN rails acc. to EN 60715
Place of installation	indoor installation
Degree of protection	IP 20
Capacity	4 module(s), DIN 43880
Approvals	VDE, KEMA, UL
Type of remote signalling contact	yes / changeover contact
Switching capacity (a.c.)	250 V / 0.5 A
Switching capacity (d.c.)	250 V / 0.1 A; 125 V / 0.2 A; 75 V / 0.5 A
Cross-sectional area for remote signalling terminals	max. 1.5 mm ² solid / flexible
For use in switchgear installations with prospective short-circuit currents of more than 50 kA _{rms} (tested by the German VDE)	-----
– Max. prospective short-circuit current	100 kA _{rms} (220 kA _{peak})
– Limitation / Extinction of mains follow currents	up to 100 kA _{rms} (220 kA _{peak})
– Max. backup fuse (L) up to $I_k = 100$ kA _{rms}	250 A gG

Use for 16.7 Hz traction power supply systems

Type	DV M2 TNS 255 FM
Part No.	954 405
– Test voltage AC (U_C)	266 V
– Nominal voltage (a.c.) (U_N)	230 / 400 V
– Nominal frequency (a.c.) (f_N)	16.7 Hz
– Max. backup fuse	160 A gG @ 16,7 Hz
Weight	524 g
Customs tariff number (Comb. Nomenclature EU)	85363090
GTIN	4013364400894
PU	1 pc(s)

DEHNshield

DSH TNS 255 FM (941 405)

- Application-optimised and prewired spark-gap-based type 1 and type 2 combined lightning current and surge arrester
- Compact design due to space-saving spark gap technology with a width of only 1 module / pole
- Allows compact lightning equipotential bonding including protection of terminal equipment



Figure without obligation

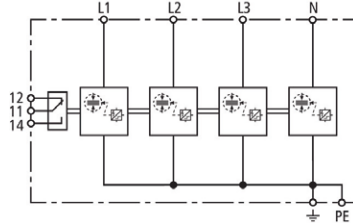

Basic circuit diagram DSH TNS 255 FM

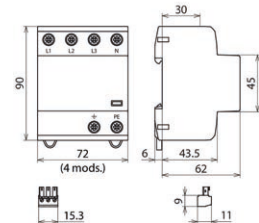

Dimension drawing DSH TNS 255 FM

Application-optimised and prewired combined lightning current and surge arrester for TN-S systems; with floating remote signalling contact.

Type	DSH TNS 255 FM
Part No.	941 405
SPD according to EN 61643-11 / IEC 61643-11	type 1 + type 2 / class I + class II
Energy coordination with terminal equipment (≤ 10 m)	type 1 + type 2 + type 3
Nominal voltage (a.c.) (U_N)	230 / 400 V (50 / 60 Hz)
Max. continuous operating voltage (a.c.) (U_C)	255 V (50 / 60 Hz)
Lightning impulse current (10/350 μ s) [L1+L2+L3+N-PE] (I_{total})	50 kA
Specific energy [L1+L2+L3+N-PE] (W/R)	625.00 kJ/ohms
Lightning impulse current (10/350 μ s) [L, N-PE] (I_{imp})	12.5 kA
Specific energy [L,N-PE] (W/R)	39.06 kJ/ohms
Nominal discharge current (8/20 μ s) [L/N-PE]/[L1+L2+L3+N-PE] (I_n)	12.5 / 50 kA
Voltage protection level [L-PE]/[N-PE] (U_P)	≤ 1.5 / ≤ 1.5 kV
Follow current extinguishing capability (a.c.) (I_e)	25 kA _{rms}
Follow current limitation / Selectivity	no tripping of a 32 A gG fuse up to 25 kA _{rms} (prosp.)
Response time (t_A)	≤ 100 ns
Max. mains-side overcurrent protection	160 A gG
Temporary overvoltage (TOV) [L-N] (U_T) – Characteristic	440 V / 120 min. – withstand
Operating temperature range (T_U)	-40 °C ... +80 °C
Operating state / fault indication	green / red
Number of ports	1
Cross-sectional area (L1, L2, L3, N, PE, \pm) (min.)	1.5 mm ² solid / flexible
Cross-sectional area (L1, L2, L3, N, PE, \pm) (max.)	35 mm ² stranded / 25 mm ² flexible
For mounting on	35 mm DIN rails acc. to EN 60715
Enclosure material	thermoplastic, red, UL 94 V-0
Place of installation	indoor installation
Degree of protection	IP 20
Capacity	4 module(s), DIN 43880
Approvals	KEMA, VDE
Type of remote signalling contact	changeover contact
Switching capacity (a.c.)	250 V / 0.5 A
Switching capacity (d.c.)	250 V / 0.1 A; 125 V / 0.2 A; 75 V / 0.5 A
Cross-sectional area for remote signalling terminals	max. 1.5 mm ² solid / flexible
Weight	428 g
Customs tariff number (Comb. Nomenclature EU)	85363090
GTIN	4013364275331
PU	1 pc(s)

DEHNcombo

DCB YPV 1200 FM (900 075)

- Applicable in PV systems in accordance with IEC 60364-7-712 / DIN VDE 0100-712
- Universally applicable in earthed and unearthed PV systems
- Prewired type 1 and type 2 combined lightning current and surge arrester for use in photovoltaic generator circuits
- Fault-resistant Y circuit prevents damage to the surge protective device in case of insulation faults in the generator circuit



Figure without obligation

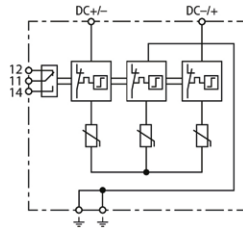

Basic circuit diagram DCB YPV 1200 FM

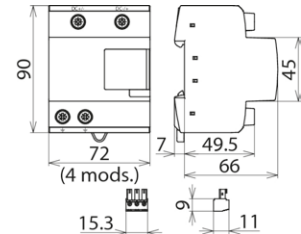

Dimension drawing DCB YPV 1200 FM

Combined lightning current and surge arrester for use in photovoltaic power supply systems up to 1200 V d.c.; with remote signalling contact.

Type	DCB YPV 1200 FM
Part No.	900 075
SPD according to EN 61643-31 / IEC 61643-31	type 1 + type 2 / class I + class II
Max. PV voltage [DC+ -> DC-] (U_{CPV})	≤ 1200 V
Max. PV voltage [DC+/DC- -> PE] (U_{CPV})	≤ 1200 V
Short-circuit current rating (I_{SCPV})	10 kA
Nominal discharge current (8/20 μ s) (I_n)	20 kA
Max. discharge current (8/20 μ s) (I_{max})	40 kA
Total discharge current (8/20 μ s) [DC+/DC- -> PE] (I_{total})	40 kA
Total discharge current (10/350 μ s) [DC+/DC- -> PE] (I_{total})	12.5 kA
Lightning impulse current (10/350 μ s) [DC+ -> PE/DC- -> PE] (I_{imp})	6.25 kA
Voltage protection level [(DC+/DC-) -> PE] (U_p)	< 3.8 kV
Voltage protection level [DC+ -> DC-] (U_p)	< 3.8 kV
Response time (t_A)	≤ 25 ns
Operating temperature range (T_U)	-40 °C ... +80 °C
Operating state / fault indication	green / red
Number of ports	1
Cross-sectional area (min.)	1.5 mm ² solid / flexible
Cross-sectional area (max.)	35 mm ² stranded / 25 mm ² flexible
For mounting on	35 mm DIN rails acc. to EN 60715
Enclosure material	thermoplastic, red, UL 94 V-0
Place of installation	indoor installation
Degree of protection	IP 20
Dimensions	4 module(s), DIN 43880
Approvals	KEMA, UL
Type of remote signalling contact	Changeover contact
Switching capacity (a.c.)	250 V / 0.5 A
Switching capacity (d.c.)	250 V / 0.1 A; 125 V / 0.2 A; 75 V / 0.5 A
Cross-sectional area for remote signalling terminals	max. 1.5 mm ² solid / flexible
Weight	511 g
Customs tariff number (Comb. Nomenclature EU)	85354000
GTIN	6942299504538
PU	1 pc(s)

DEHNcombo

DCB YPV 1500 FM (900 076)

- Applicable in PV systems in accordance with IEC 60364-7-712 / DIN VDE 0100-712
- Universally applicable in earthed and unearthed PV systems
- Prewired type 1 and type 2 combined lightning current and surge arrester for use in photovoltaic generator circuits
- Fault-resistant Y circuit prevents damage to the surge protective device in case of insulation faults in the generator circuit



Figure without obligation

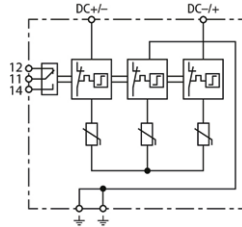

Basic circuit diagram DCB YPV 1500 FM

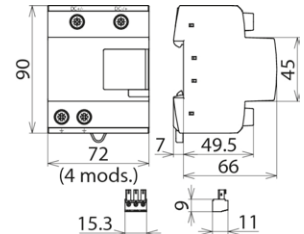

Dimension drawing DCB YPV 1500 FM

Combined lightning current and surge arrester for use in photovoltaic power supply systems up to 1500 V d.c.; with remote signalling contact.

Type Part No.	DCB YPV 1500 FM 900 076
SPD according to EN 61643-31 / IEC 61643-31	type 1 + type 2 / class I + class II
Max. PV voltage [DC+ -> DC-] (U_{CPV})	≤ 1500 V
Max. PV voltage [DC+/DC- -> PE] (U_{CPV})	≤ 1500 V
Short-circuit current rating (I_{SCPV})	10 kA
Nominal discharge current (8/20 μ s) (I_n)	20 kA
Max. discharge current (8/20 μ s) (I_{max})	40 kA
Total discharge current (8/20 μ s) [DC+/DC- -> PE] (I_{total})	40 kA
Total discharge current (10/350 μ s) [DC+/DC- -> PE] (I_{total})	12.5 kA
Lightning impulse current (10/350 μ s) [DC+ -> PE/DC- -> PE] (I_{imp})	6.25 kA
Voltage protection level [(DC+/DC-) -> PE] (U_p)	< 4.5 kV
Voltage protection level [DC+ -> DC-] (U_p)	< 4.5 kV
Response time (t_A)	≤ 25 ns
Operating temperature range (T_U)	-40 °C ... +80 °C
Operating state / fault indication	green / red
Number of ports	1
Cross-sectional area (min.)	1.5 mm ² solid / flexible
Cross-sectional area (max.)	35 mm ² stranded / 25 mm ² flexible
For mounting on	35 mm DIN rails acc. to EN 60715
Enclosure material	thermoplastic, red, UL 94 V-0
Place of installation	indoor installation
Degree of protection	IP 20
Dimensions	4 module(s), DIN 43880
Approvals	KEMA, UL
Type of remote signalling contact	changeover contact
Switching capacity (a.c.)	250 V / 0.5 A
Switching capacity (d.c.)	250 V / 0.1 A; 125 V / 0.2 A; 75 V / 0.5 A
Cross-sectional area for remote signalling terminals	max. 1.5 mm ² solid / flexible
Extended technical data:	-----
- Use in DC battery storage systems up to I_{SCCR}	≤ 50 kA ($t \leq 4$ ms)
- Backup fuse for DC battery storage systems up to I_{SCCR}	Bussman HLS 2000Vdc / 200 A 2+/A173 DST aR, manufacturer's Part No.: 170M2040
Weight	564 g
Customs tariff number (Comb. Nomenclature EU)	85354000
GTIN	6942299504552
PU	1 pc(s)

DEHNguard

DG M YPV 1200 FM (952 565)

- Modular prewired complete unit for use in photovoltaic systems consisting of a base part and plug-in protection modules
- High reliability due to "Thermo Dynamic Control" SPD monitoring device
- Tried and tested fault-resistant Y circuit



Figure without obligation

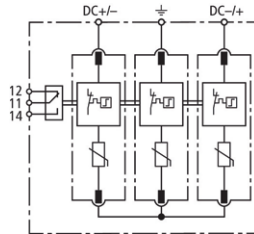

Basic circuit diagram DG M YPV 1200 FM

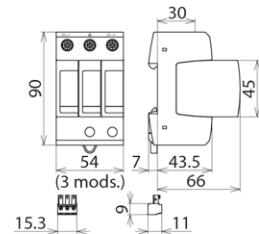

Dimension drawing DG M YPV 1200 FM

Multipole modular surge arrester for use in PV systems; with remote signalling contact for monitoring unit (floating changeover contact).

Type	DG M YPV 1200 FM
Part No.	952 565
SPD according to EN 61643-31 / IEC 61643-31	type 2 / class II
Max. PV voltage (U_{CPV})	1170 V
Short-circuit current rating (I_{SCPV})	10 kA
Total discharge current (8/20 μ s) (I_{total})	40 kA
Nominal discharge current (8/20 μ s) [(DC+/DC-) --> PE] (I_n)	20 kA
Max. discharge current (8/20 μ s) [(DC+/DC-) --> PE] (I_{max})	40 kA
Voltage protection level (U_p)	≤ 4 kV
Response time (t_A)	≤ 25 ns
Operating temperature range (T_U)	-40 °C ... +80 °C
Operating state / fault indication	green / red
Number of ports	1
Cross-sectional area (min.)	1.5 mm ² solid / flexible
Cross-sectional area (max.)	35 mm ² stranded / 25 mm ² flexible
For mounting on	35 mm DIN rails acc. to EN 60715
Enclosure material	thermoplastic, red, UL 94 V-0
Place of installation	indoor installation
Degree of protection	IP 20
Capacity	3 module(s), DIN 43880
Approvals	UL, KEMA
Type of remote signalling contact	changeover contact
Switching capacity (a.c.)	250 V / 0.5 A
Switching capacity (d.c.)	250 V / 0.1 A; 125 V / 0.2 A; 75 V / 0.5 A
Cross-sectional area for remote signalling terminals	max. 1.5 mm ² solid / flexible
Extended technical data:	-----
- Use in DC battery storage systems up to I_{SCCR}	≤ 50 kA ($t \leq 4$ ms)
- Backup fuse for DC battery storage systems up to I_{SCCR}	Bussman HLS 2000Vdc / 200 A 2+/A173 DST aR, manufacturer's Part. No.: 170M2040
Weight	300 g
Customs tariff number (Comb. Nomenclature EU)	85363030
GTIN	4013364327719
PU	1 pc(s)

DEHNguard

DG M YPV 1500 FM (952 567)

- High discharge capacity due to powerful zinc oxide varistors
- Modular prewired complete unit for use in photovoltaic systems consisting of a base part and plug-in protection modules
- Tried and tested fault-resistant Y circuit



Figure without obligation

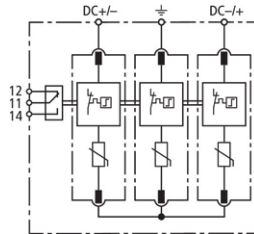

Basic circuit diagram DG M YPV 1500 FM

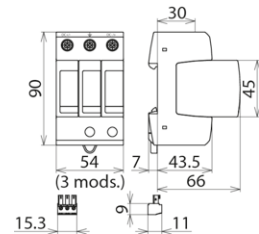

Dimension drawing DG M YPV 1500 FM

Multipole modular surge arrester for use in PV systems; with remote signalling contact for monitoring unit (floating changeover contact).

Type	DG M YPV 1500 FM	
Part No.	952 567	
SPD according to EN 61643-31 / IEC 61643-31	type 2 / class II	
Max. PV voltage (U_{CPV})	1500 V	
Short-circuit current rating (I_{SCPV})	10 kA	
Total discharge current (8/20 μ s) (I_{total})	40 kA	
Nominal discharge current (8/20 μ s) [(DC+/DC-) --> PE] (I_n)	15 kA	
Max. discharge current (8/20 μ s) [(DC+/DC-) --> PE] (I_{max})	40 kA	
Voltage protection level (U_p)	≤ 5 kV	
Response time (t_A)	≤ 25 ns	
Operating temperature range (T_U)	-40 °C ... +80 °C	
Operating state / fault indication	green / red	
Number of ports	1	
Cross-sectional area (min.)	1.5 mm ² solid / flexible	
Cross-sectional area (max.)	35 mm ² stranded / 25 mm ² flexible	
For mounting on	35 mm DIN rails acc. to EN 60715	
Enclosure material	thermoplastic, red, UL 94 V-0	
Place of installation	indoor installation	
Degree of protection	IP 20	
Capacity	3 module(s), DIN 43880	
Approvals	UL, KEMA	
Type of remote signalling contact	changeover contact	
Switching capacity (a.c.)	250 V / 0.5 A	
Switching capacity (d.c.)	250 V / 0.1 A; 125 V / 0.2 A; 75 V / 0.5 A	
Cross-sectional area for remote signalling terminals	max. 1.5 mm ² solid / flexible	
Extended technical data:	-----	
- Use in DC battery storage systems up to I_{SCCR}	≤ 50 kA ($t \leq 4$ ms)	
- Backup fuse for DC battery storage systems up to I_{SCCR}	Bussman HLS 2000Vdc / 200 A 2+/A173 DST aR, manufacturer's Part No.: 170M2040	
Weight	329 g	
Customs tariff number (Comb. Nomenclature EU)	85363030	
GTIN	4013364327726	
PU	1 pc(s)	

DEHNbox

DBX TC B 180 (922 220)

- Arrester monitoring and integrated status indication
- Two-pole wall-mounted arrester for optimal protection of telecommunication interfaces
- For installation in conformity with the lightning protection zone concept at the boundaries from LPZ 0_A to 2 and higher
- Tests by Deutsche Telekom Technik GmbH confirm compatibility with vectoring VDSL (VVDSL), super vectoring VDSL (SVVDSL) and G.Fast.



Figure without obligation

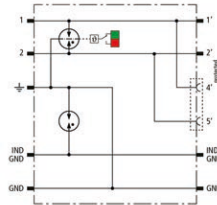

Basic circuit diagram DBX TC B 180

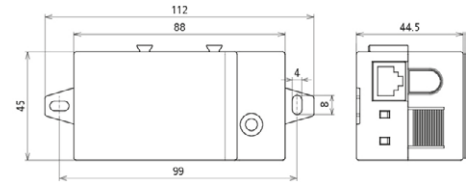

Dimension drawing DBX TC B 180

Space-saving, compact combined arrester in a surface-mounted plastic enclosure with push-in technology and status indication for protecting one pair of unearthed balanced interfaces, particularly telecommunication interfaces up to VVDSL and G.fast (up to 1 G.Bit/s). Direct / indirect shield earthing possible. Connection of a pair or a patch cable with RJ45 plug at the output.

Type	DBX TC B 180
Part No.	922 220
SPD class	TYPE 1P2
Impulse category	D1, C1, C2, C3
Nominal voltage (U_N)	180 V
Max. continuous operating voltage (d.c.) (U_C)	180 V
Max. continuous operating voltage (a.c.) (U_C)	127 V
Nominal current (I_N)	1 A
D1 Total lightning impulse current (10/350 μ s) (I_{imp})	7.5 kA
D1 Lightning impulse current (10/350 μ s) per line (I_{imp})	2.5 kA
C2 Total nominal discharge current (8/20 μ s) (I_n)	20 kA
C2 Nominal discharge current (8/20 μ s) per line (I_n)	10 kA
Voltage protection level line-line for I_n C2 (U_p)	≤ 700 V
Voltage protection level line-PG for I_n C2 (U_p)	≤ 550 V
Voltage protection level line-line at 1 kV/ μ s C3 (U_p)	≤ 620 V
Voltage protection level line-PG at 1 kV/ μ s C3 (U_p)	≤ 550 V
Series resistance per line	0 ohms
Cut-off frequency (f_c)	425 MHz
Capacitance line-line (C)	≤ 10 pF
Capacitance line-PG (C)	≤ 20 pF
Operating temperature range (T_U)	-25 °C ... +80 °C
Operating state / fault indication	green / red
Degree of protection	IP 20
Cross-sectional area (solid)	0.2-1.5 mm ²
Cross-sectional area (flexible)	0.25-1.5 mm ²
Cross-sectional area of the earth terminal	0.08-4 mm ²
Enclosure material	polyamide PA 6.6
Connection (input)	push-in
Connection (output)	push-in / RJ45
Colour	yellow
Test standards	IEC 61643-21 / EN 61643-21
Approvals	null
Weight	64 g
Customs tariff number (Comb. Nomenclature EU)	85363030
GTIN	4013364433953
PU	1 pc(s)

BLITZDUCTOR

BCO ML2 BD HF 5 (927 271)

- LifeCheck arrester monitoring and integrated status indication
- Modular two-pole arrester for optimal protection of one pair of high-frequency signal circuits
- For installation in conformity with the lightning protection zone concept at the boundaries from $0_A - 2$ and higher



Figure without obligation

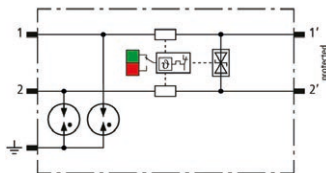

Basic circuit diagram BCO ML2 BD HF 5

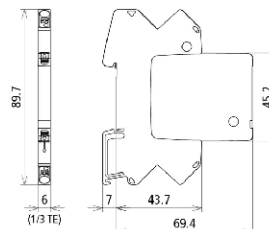

Dimension drawing BCO ML2 BD HF 5

Space-saving, modular combined arrester with a width of 6 mm and push-in connection technology with status indication for protecting one pair of unearthed high-frequency bus systems as well as balanced interfaces. With signal disconnection for maintenance purposes.

Type	BCO ML2 BD HF 5
Part No.	927 271
SPD class	TYPE 1 P2
Impulse category	D1, C1, C2, C3, B2
Nominal voltage (U_N)	5 V
Max. continuous operating voltage (d.c.) (U_C)	8.5 V
Max. continuous operating voltage (a.c.) (U_C)	6.0 V
Nominal current at 70 °C (I_L)	0.75 A
D1 Total lightning impulse current (10/350 μ s) (I_{imp})	3 kA
D1 Lightning impulse current (10/350 μ s) per line (I_{imp})	1.5 kA
C2 Total nominal discharge current (8/20 μ s) (I_n)	10 kA
C2 Nominal discharge current (8/20 μ s) per line (I_n)	5 kA
Voltage protection level line-line for I_n C2 (U_p)	≤ 42 V
Voltage protection level line-PG for I_n C2 (U_p)	≤ 600 V
Voltage protection level line-line for I_n C1 (U_p)	≤ 42 V
Voltage protection level line-PG for I_n C1 (U_p)	≤ 600 V
Voltage protection level line-line at 1 kV/ μ s C3 (U_p)	≤ 15 V
Voltage protection level line-PG at 1 kV/ μ s C3 (U_p)	≤ 600 V
Series resistance per line	1 ohm(s)
Cut-off frequency line-line (f_c)	100 MHz
Operating temperature range (T_U)	-40 °C ... +80 °C
Operating state / fault indication	green / red
Degree of protection	IP 20
Connection (input / output)	push-in / push-in
Cross-sectional area (solid)	0.2-2.5 mm ²
Cross-sectional area (flexible)	0.2-2.5 mm ²
Earthing via	35 mm DIN rails acc. to EN 60715
Enclosure material	polyamide PA 6.6
Colour	yellow
Test standards	IEC 61643-21 / EN 61643-21
Approvals	UL, CSA, EAC, ATEX, IECEx, CCC, SIL
ATEX approvals	TÜV 20 ATEX 8527 X: II 3G Ex ec IIC T4 Gc
IECEx approvals	IECEx TUR 20.0063X: Ex ec IIC T4 Gc
China Compulsory Certification	CCC no. 2021312304001192
Extended technical data:	-----
- Max. discharge current (8/20 μ s) [1/2 - PG], [1+2 - PG] (I_{max})	20 kA
- Discharge current (8/20 μ s) [1/2 - PG], [1+2 - PG]	10 kA (10x)
- Voltage protection level line-PG at 1 kV/ μ s C3 after being subjected to I_{max} (U_p)	≤ 600 V
Weight	34 g
Customs tariff number (Comb. Nomenclature EU)	85363010

UNI saddle clamp

UNI FK 8.10 KBF0.7 8 AL V2A (365 250)



Figure without obligation

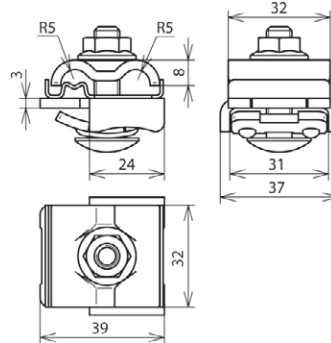

For integrating mounting systems, e.g. of PV installations, in the functional equipotential bonding / functional earthing (black conductor possible) and lightning equipotential bonding according to IEC/EN 62305-3.

The StSt contact plate (intermediate element) allows different conductor materials (Cu, Al, St/tZn and StSt) to be connected to the normal mounting systems, e.g. to aluminium, without the risk of contact corrosion.

The double clamp design allows easy and quick interconnection of the profiles, e.g. by feed-through wiring.



Arrangement:

Type	UNI FK 8.10 KBF0.7 8 AL V2A
Part No.	365 250
Clamping range of saddle	0.7-8 mm
Material of clamping bracket	Al
Material thickness	3 mm
Clamping range Rd	8-10 mm
Connection (solid / stranded)	4-50 mm ²
Material of double clamp	StSt
Screw	☝ M8 x 35 mm
Self-locking nut	width across flats 13 mm
Material of screw / nut	StSt
Connecting direction	lengthwise / crosswise
Lightning current carrying capability (10/350 µs)	 50kA ^{*)}
Standard	EN 62561-1
Weight	83 g
Customs tariff number (Comb. Nomenclature EU)	85389099
GTIN	4013364148307
PU	50 pc(s)

*) See test certificate for exact classification.

SV clamp

SVK 7.10 7.10 FL30 STTZN (308 220)

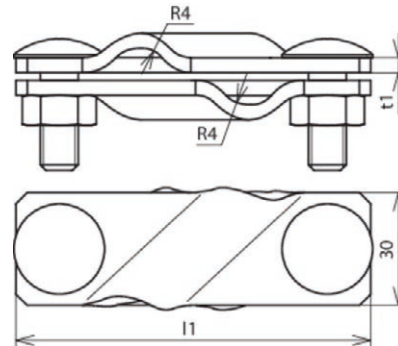



Figure without obligation



Arrangement:

Type	SVK 7.10 7.10 FL30 STTZN
Part No.	308 220
Material of clamp	St/tZn
Clamping range Rd / Rd	7-10 / 7-10 mm
Clamping range Rd / FI	7-10 / 30 mm
Clamping range FI / FI	30 / 30 mm
Screw	⬆ M10 x 30 mm
Material of screw / nut	St/tZn
Dimensions (l1 x d1)	94 x 4 mm
Lightning current carrying capability (10/350 μs)	 /  *)
Standard	EN 62561-1
Short-circuit current (a.c. 50 Hz / d.c.) (1 s; ≤ 300 °C)	7.3 kA
Weight	250 g
Customs tariff number (Comb. Nomenclature EU)	85389099
GTIN	4013364084216
PU	25 pc(s)

*) For exact assignment see test certificate.

MV clamp

MVK 8.10 SKM10X35 V4A (390 079)

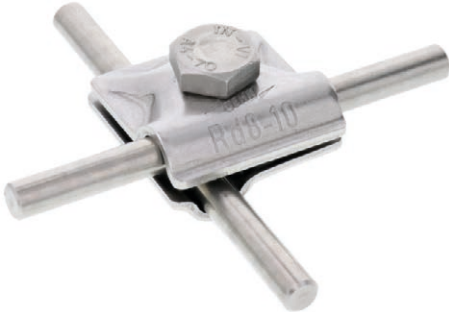
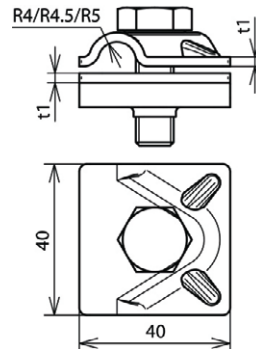



Figure without obligation



Clamp also suits for underground application.



Arrangement:

Type	MVK 8.10 SKM10X35 V4A
Part No.	390 079
Material of clamp	StSt (V4A)
Clamping range Rd	8-10 mm
Material thickness (t1 / t2)	2.5 mm
Screw	 M10 x 35 mm
Material of screw / nut	StSt (V4A)
Material No.	1.4571 / 1.4404 / 1.4401
ASTM / AISI:	316Ti / 316L / 316
Lightning current carrying capability (10/350 µs)	 100 kA ^{*)}
Standard	EN 62561-1
Short-circuit current (a.c. 50 Hz / d.c.) (1 s; ≤ 300 °C)	4.7 kA
Weight	96 g
Customs tariff number (Comb. Nomenclature EU)	85389099
GTIN	4013364128996
PU	50 pc(s)

Note: Part No. 390 079 made of StSt (V4A) can also be used underground.

*) For exact assignment see test certificate.

Round wire

RD 10 STTZN R30M (800 310)



Figure without obligation

Steel wire according to EN 62561-2 with zinc coating $\geq 50 \mu\text{m}$ on average (about 350 g/m^2), for use in lightning protection and earth-termination systems.

Type Part No.	RD 10 STTZN R30M 800 310
Diameter \varnothing conductor	10 mm
Cross-section	78 mm^2
Material	St/tZn
Standard	based on EN 62561-2
Zinc sheath	$\geq 50 \mu\text{m}$ average (about 350 g/m^2)
Conductivity	$\geq 6.66 \text{ m} / \text{Ohm mm}^2$
Resistivity	$\leq 0.25 \text{ Ohm mm}^2 / \text{m}$
Short-circuit current (a.c. 50 Hz / d.c.) (1 s; $\leq 300 \text{ }^\circ\text{C}$)	5.5 kA
Weight	617 g/m
Customs tariff number (Comb. Nomenclature EU)	72172030
GTIN	4013364131064
PU	30 m

RD 10 V4A R80M (860 010)

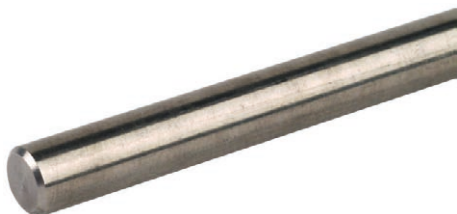

Figure without obligation

Stainless steel wire according to EN 62561-2, for lightning protection and earth-termination systems or equipotential bonding.

Stainless steel wires for use in soil have to be made of StSt (V4A) with a molybdenum content $> 2 \%$ e.g. 1.4571, 1.4404, in accordance with EN 62561-2 and IEC/EN 62305-3.

Type Part No.	RD 10 V4A R80M 860 010
Diameter \varnothing conductor	10 mm
Cross-section	78 mm^2
Material	StSt (V4A)
Material No.	1.4571 / 1.4404
ASTM / AISI:	316Ti / 316L
Standard	based on EN 62561-2
Conductivity	$\geq 1.25 \text{ m} / \text{Ohm mm}^2$
Resistivity	$\leq 0.8 \text{ Ohm mm}^2 / \text{m}$
Short-circuit current (a.c. 50 Hz / d.c.) (1 s; $\leq 300 \text{ }^\circ\text{C}$)	2.9 kA
Weight	617 g/m
Customs tariff number (Comb. Nomenclature EU)	72210010
GTIN	4013364019997
PU	80 m

Flat strip

BA 30X3.5 STTZN R25M (852 335)



Figure without obligation

Steel strip according to EN 62561-2 with zinc coating $\geq 70 \mu\text{m}$ on average (about 500 g/m^2), for lightning protection and earth-termination systems.

Type	BA 30X3.5 STTZN R25M
Part No.	852 335
Width	30 mm
Thickness	3.5 mm
Cross-section	105 mm^2
Material	St/tZn
Standard	EN 62561-2
Zinc coating	$\geq 70 \mu\text{m}$ average (about 500 g/m^2)
Conductivity	$\geq 6.66 \text{ m} / \text{Ohm mm}^2$
Resistivity	$\leq 0.15 \text{ Ohm mm}^2 / \text{m}$
Short-circuit current (a.c. 50 Hz / d.c.) (1 s; $\leq 300 \text{ }^\circ\text{C}$)	7.4 kA
Weight	840 g/m
Customs tariff number (Comb. Nomenclature EU)	72123000
GTIN	4013364031067
PU	25 m

BA 30X3.5 V4A R25M (860 325)



Figure without obligation

Stainless steel strip according to EN 62561-2, for lightning protection systems and ring equipotential bonding.

Stainless steel strip for use in soil have to be made of StSt (V4A) with a molybdenum content $> 2 \%$ e.g. 1.4571, 1.4404 in accordance with EN 62561-2, IEC/EN 62305-3 and DIN VDE 0151.

Type	BA 30X3.5 V4A R25M
Part No.	860 325
Width	30 mm
Thickness	3.5 mm
Cross-section	105 mm^2
Material	StSt (V4A)
Material No.	1.4571 / 1.4404
ASTM / AISI:	316Ti / 316L
Standard	EN 62561-2
Conductivity	$\geq 1.25 \text{ m} / \text{Ohm mm}^2$
Resistivity	$\leq 0.8 \text{ Ohm mm}^2 / \text{m}$
Short-circuit current (a.c. 50 Hz / d.c.) (1 s; $\leq 300 \text{ }^\circ\text{C}$)	3.9 kA
Weight	825 g/m
Customs tariff number (Comb. Nomenclature EU)	72202021
GTIN	4013364093157
PU	25 m

Surge Protection
Lightning Protection
Safety Equipment
DEHN protects.

DEHN SE
Hans-Dehn-Str. 1
Postfach 1640
92306 Neumarkt, Germany

Tel. +49 9181 906-0
Fax +49 9181 906-1100
info@dehn.de
www.dehn-international.com



www.dehn-international.com/partners

Type designations of products mentioned in this white paper which are at the same time registered trademarks are not especially marked. Hence the absence of TM or [®] markings does not indicate that the type designation is a free trade name. Nor can it be seen whether patents or utility models and other intellectual and industrial property rights exist. We reserve the right to introduce changes in performance, configuration and technology, dimensions, weights and materials in the course of technical progress. The figures are shown without obligation. Misprints, errors and modifications excepted. Reproduction in any form whatsoever is forbidden without our authorisation.