

# MEDIUM VOLTAGE TERMINATIONS

CATALOGUE 2017





NEXANS NETWORK SOLUTIONS DIV. EUROMOLD

# COMPANY PRESENTATION



## EUROMOLD

Euromold is the leading European specialised designer, manufacturer and distributor of prefabricated cable accessories for medium voltage energy distribution. Euromold provides a complete range of accessories for underground cables: premoulded EPDM rubber connectors for cables and epoxy bushings for transformers and switchgear, as well as a large range of cold-shrinkable terminations and joints from 12 to 42 kV. Euromold is also the manufacturer of electrical components for the high voltage accessories of the Nexans group.

## ISO 9001 Certificate

Since 1992, Euromold's commitment to quality is demonstrated by its ISO 9001 certification.

## International standards

All our products meet the International standards like CENELEC HD 629.1, CENELEC EN 50180, IEC 60137, IEC 60502-4... or country specifications. Official certificates, CESI, KEMA, ATEX... prove the conformity of our products. Long duration tests of existing or new products are continuously performed in our test fields.

## Laboratory accreditation

Since June 2000, Euromold's independent ELAB laboratory obtained the BELAC accreditation no.144-TEST conform with the European standards for laboratories ISO 17025 for electrical testing of low and medium voltage cable accessories according to the international standards EN 50393, IEC 60502-4, IEC 61442 and HD 629.



While every care is taken to ensure that the information contained in this publication is correct, no legal responsibility can be accepted for any inaccuracy. Nexans Network Solutions N.V. - Div. Euromold reserves the right to alter or modify the characteristics of its products described in this catalogue as standards and technology evolve.



# TERMINATIONS

## TABLE OF CONTENTS

ITK - indoor termination

OTK - outdoor termination

AIN - indoor termination

AFN - outdoor termination

T-ITK - 3-core indoor termination

T-OTK - 3-core outdoor termination

15TS-NSS - universal bushing boot

### APPLICATION

A kit of 3 terminations for use indoors in controlled environmental conditions and subject to light condensation. To connect polymeric insulated cable to equipment.

### DESIGN

- Indoor termination comprising:
1. Cable lug (not included in the standard kit).
  2. Water sealing mastic.
  3. Silicone tube.
  4. Stress control mastic.
  5. Conductive EPDM ring.

### SPECIFICATIONS AND STANDARDS

Meets the requirements of CENELEC HD 629.1.

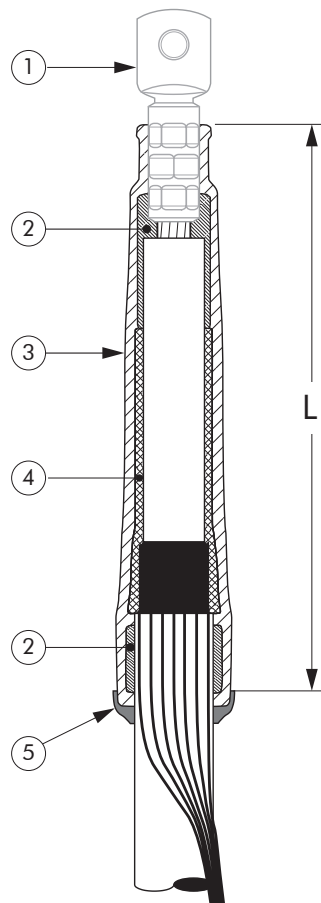

6/10 (12) kV  
6.35/11 (12) kV  
8.7/15 (17.5) kV  
12/20 (24) kV  
12.7/22 (24) kV

**Up to 24 kV**

Termination type	Voltage Um (kV)	Strike distance L (mm)	Diameter over core insulation (mm)		Conductor sizes (mm <sup>2</sup> )	
			min	max	min	max
ITK 212	12	260	14	33	50	400
ITK 312	12	300	30	50	400	1000
ITK 224	24	260	14	33	25	240
ITK 324	24	300	30	50	300	800

## KIT CONTENTS

The complete ITK termination kit comprises the following components:

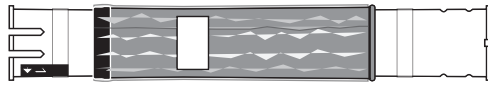

= 3 x ITK 212 or ITK 224 termination kit

3 x Factory pre-assembled silicone tubes comprising stress relief and sealing mastic.

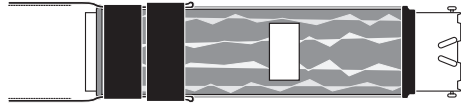

= 3 x ITK 312 or ITK 324 termination kit

3 x Factory pre-assembled silicone tubes comprising stress relief and sealing mastic.

The kit also comprises water sealing mastic and installation instructions.

## ORDERING INSTRUCTIONS

Select the part number corresponding to both the system voltage and the cable insulation diameter in mm.

### EXAMPLE:

The copper wire screened cable is 12 kV, 150 mm<sup>2</sup> stranded aluminium.

The diameter over core insulation is 26.2 mm.

Order a 3 x ITK 212 termination kit.

Ordering part number	Voltage Um (kV)	Diameter over core insulation (mm)		Conductor sizes (mm <sup>2</sup> )	
		min	max	min	max
3 x ITK 212	12	14	33	50	400
3 x ITK 312	12	30	50	400	1000
3 x ITK 224	24	14	33	25	240
3 x ITK 324	24	30	50	300	800

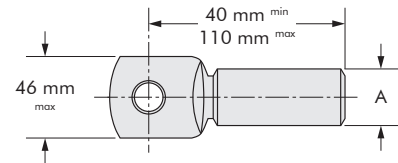

All commercialised European standard cable lugs can be used.

Cable lugs should be within the dimensions specified (not applicable for ITK 312 and ITK 324).

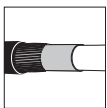

For use with copper wire screened cables. No earthing device is necessary.

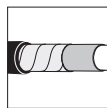

For use with copper tape screened cables. Also order a Kit MT.

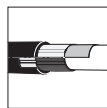

For use with Alupe or C 33-226 cables. Please contact our representative.



For use with three-core cables: see T-ITK.

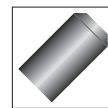

If the cable lug barrel diameter (A) is less than 20 mm: order a rubber adapting sleeve.

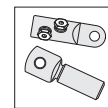

Can be supplied with all common types of cable lugs.

### APPLICATION

A kit of 3 terminations for use outdoors and exposed to prolonged sunshine and other weather conditions.

To connect polymeric insulated cable to equipment and for the outdoor terminating on to overhead lines or busbars.



### DESIGN

Outdoor termination comprising:

1. Cable lug (not included in the standard kit).
2. Water sealing mastic.
3. Sheds which can be installed upwards or down.
4. Silicone tube with sheds.
5. Silicone tube.
6. Stress control mastic.
7. Conductive EPDM ring.

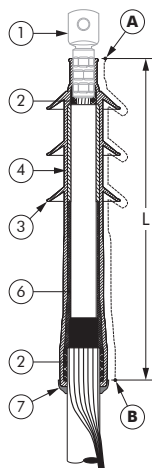

Fig. 1

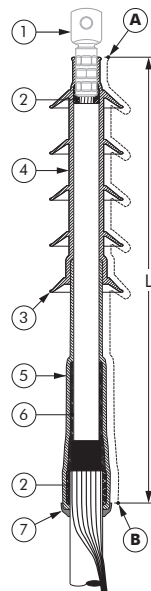

Fig. 2

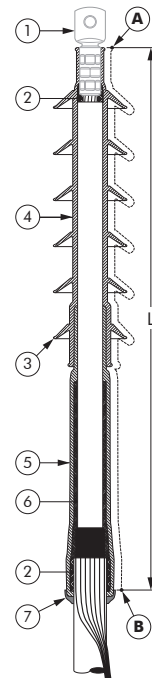

Fig. 3

6/10 (12) kV  
6.35/11 (12) kV  
8.7/15 (17.5) kV  
12/20 (24) kV  
12.7/22 (24) kV

**Up to 24 kV**

### SPECIFICATIONS AND STANDARDS

Meets the requirements of CENELEC HD 629.1.

Termination type	Voltage $U_m$ (kV)	Creepage distance A-B (mm)	Strike distance "L" (mm)	Diameter over core insulation (mm)		Number of sheds	Conductor sizes (mm <sup>2</sup> )		Fig. no.
				min	max		min	max	
OTK 212	12	420	300	14	33	3	50	400	1
OTK 312	12	890	650	30	50	6	500	1000	3
OTK 224	24	600	400	19	33	5	50	240	2
OTK 324	24	890	650	30	50	6	300	630	3



## KIT CONTENTS

The complete OTK termination kit comprises the following components:

The kit also comprises water sealing mastic and installation instructions.

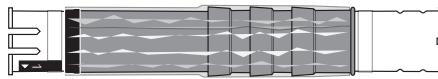

3 x Factory pre-assembled silicone tubes comprising stress relief and sealing mastic.

= 3 x OTK 212 termination kit

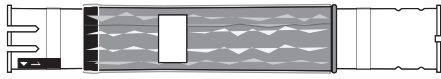

3 x Factory pre-assembled silicone tubes comprising stress relief and sealing mastic.

+

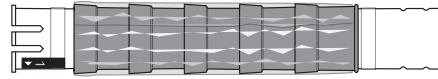

3 x Silicone tube with 5 sheds

= 3 x OTK 224 termination kit

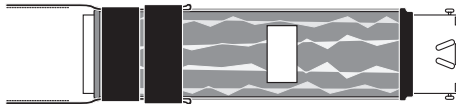

3 x Factory pre-assembled silicone tubes comprising stress relief and sealing mastic.

+

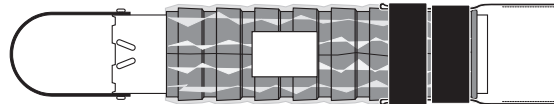

3 x Silicone tube with 6 sheds

= 3 x OTK 312  
or  
3 x OTK 324 termination kit

## ORDERING INSTRUCTIONS

Select the part number corresponding to both the system voltage and the cable insulation diameter in mm.

### EXAMPLE:

The copper wire screened cable is 24 kV, 150 mm<sup>2</sup> stranded aluminium.

The diameter over core insulation is 26.2 mm.

Order a 3 x OTK 224 termination kit.

Ordering part number	Voltage U <sub>m</sub> (kV)	Diameter over core insulation (mm)		Conductor sizes (mm <sup>2</sup> )	
		min	max	min	max
3 x OTK 212	12	14	33	50	400
3 x OTK 312	12	30	50	500	1000
3 x OTK 224	24	19	33	50	240
3 x OTK 324	24	30	50	300	800

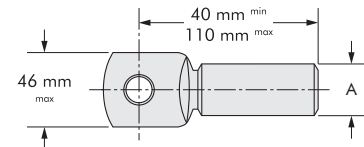

All commercialised European standard cable lugs can be used.

Cable lugs should be within the dimensions specified (not applicable for OTK 312 and OTK 324).

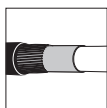

For use with copper wire screened cables. No earthing device is necessary.

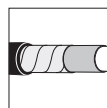

For use with copper tape screened cables. Also order a Kit MT.

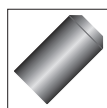

If the cable lug barrel diameter (A) is less than 20 mm: order a rubber adapting sleeve.

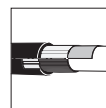

For use with Alupe or C 33-226 cables. Please contact our representative.



For use with three-core cables: see T-OTK.

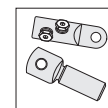

Can be supplied with all common types of cable lugs.

### APPLICATION

A kit of 3 terminations for use indoors in controlled environmental conditions and subject to light condensation. Provides a simple and quick method of stress relieving on screened polymeric cables.



### DESIGN

Indoor termination comprising:

1. Cable lug (not included in the standard kit).
2. High flexibility silicone rubber housing, allowing larger tolerances on cable insulation diameters, with integrated conductive rubber insert, providing stress relief.
3. Earthing lug (not included in the standard kit).

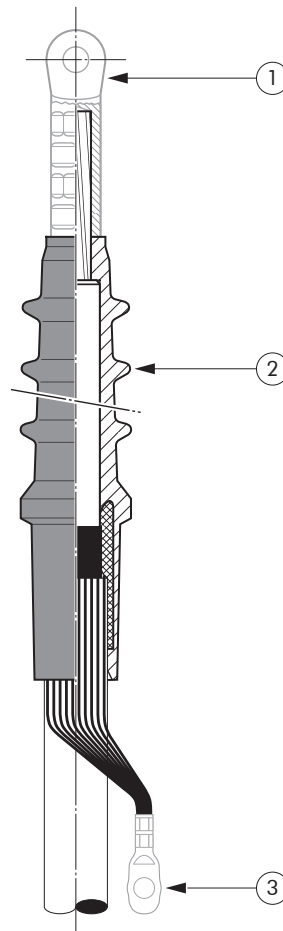

6/10 (12) kV  
6.35/11 (12) kV  
8.7/15 (17.5) kV  
12/20 (24) kV  
12.7/22 (24) kV  
18/30 (36) kV  
20.8/36 (42) kV

**Up to 42 kV**

### SPECIFICATIONS AND STANDARDS

Meets the requirements of CENELEC HD 629.1 and IEC 60502-4.

Termination type	Voltage Um (kV)	Conductor sizes (mm <sup>2</sup> )	
		min	max
AIN 10	12	25	1200
AIN 20	24	35	1200
AIN 30	36	50	1000
AIN 36	42	150	1000

05/2017

## KIT CONTENTS

A kit always comprises  
3 termination housings,  
installation instructions, special  
lubricant, wiper, adhesive tape,  
field control mastic, ...

## ORDERING INSTRUCTIONS

Select the part number  
corresponding to both the system  
voltage and the cable dimensions  
in mm.

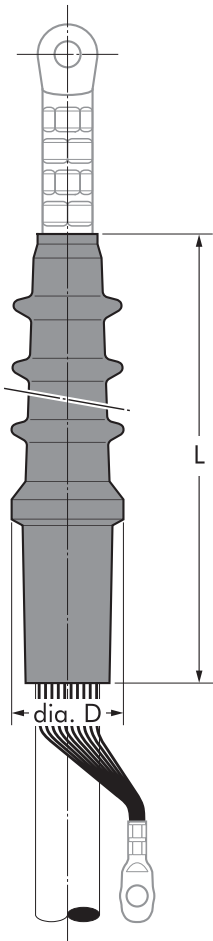

Cable lugs and earthing lugs are  
not included in the standard kit,  
but can be ordered separately.

Voltage Um (kV)	Conductor sizes (mm <sup>2</sup> )		Diameter over core insulation (mm)		Number of sheds	L (mm)	Dia. D (mm)	Ordering part number
	min	max	min	max				
12	25	95	12.7	21.0	2	150	37	3 x AIN 10-1
	120	240	19.0	28.5	2	150	43	3 x AIN 10-2
	300	500	27.0	37.0	2	150	60	3 x AIN 10-3
	630	800	34.0	46.0	3	225	68	3 x AIN 20-4
	1000	1200	39.0	50.0	7	405	98	3 x AIN 36-5
			46.0	58.0	7	405	98	3 x AIN 36-6
24	35	70	18.0	23.5	3	225	47	3 x AIN 20-1
	95	240	22.5	33.0	3	225	56	3 x AIN 20-2
	300	500	31.0	41.0	3	225	68	3 x AIN 20-3
	400	630	34.0	46.0	3	225	68	3 x AIN 20-4
	630	800	39.0	50.0	7	405	98	3 x AIN 36-5
	1000	1200	46.0	58.0	7	405	98	3 x AIN 36-6
36	50	70	23.5	29.0	6	300	74	3 x AIN 30-1
	95	240	27.0	38.0	6	300	74	3 x AIN 30-2
	240	400	32.0	43.0	6	300	81	3 x AIN 30-3
	400	630	39.0	50.0	7	405	98	3 x AIN 36-5
	630	1000	46.0	58.0	7	405	98	3 x AIN 36-6
42	150	300	31.5	41.0	7	405	98	3 x AIN 36-4
	400	630	39.0	50.0	7	405	98	3 x AIN 36-5
	630	1000	46.0	58.0	7	405	98	3 x AIN 36-6

### EXAMPLE:

A set of 3 indoor terminations  
for a 24 kV - 240 mm<sup>2</sup> stranded  
aluminium cable with copper wire  
screen without cable lugs.

The diameter over core insulation  
is 30.4 mm.

Order a 3 x AIN 20-2  
termination kit.

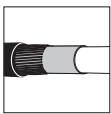

For use with copper  
wire screened cables.  
No earthing  
device is  
necessary.

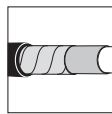

For use with  
copper tape  
screened cables.  
Order: -/MT.



For use with  
three-core cables.  
Please contact our  
representative.



For use with other  
cable types.  
Please contact our  
representative.

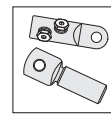

Can be supplied with  
all common types of  
cable lugs.



No heating or flame  
is required.

### APPLICATION

A kit of 3 terminations for use outdoors and exposed to prolonged sunshine and other weather conditions.

To connect polymeric insulated cable to equipment and for the outdoor terminating on to overhead lines or busbars.



### DESIGN

Outdoor termination comprising:

1. Cable lug (not included in the standard kit).
2. Water sealing silicone sleeve.
3. Silicone housing with sheds and integrated conductive silicone rubber insert providing stress relief for the cable.
4. Water sealing mastic.
5. Earthing clamp.
6. Earthing lug (not included in the standard kit).

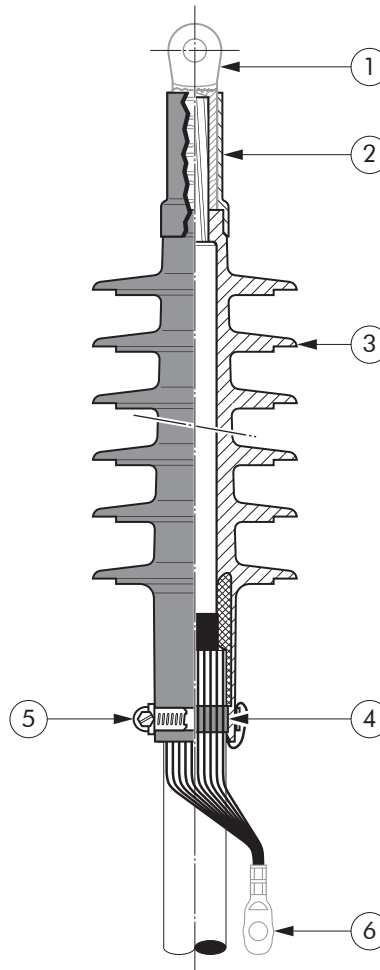

6/10 (12) kV  
6.35/11 (12) kV  
8.7/15 (17.5) kV  
12/20 (24) kV  
12.7/22 (24) kV  
18/30 (36) kV  
20.8/36 (42) kV

**Up to 42 kV**

### SPECIFICATIONS AND STANDARDS

Meets the requirements of CENELEC HD 629.1 and IEC 60502-4.

Termination type	Voltage $U_m$ (kV)	Conductor sizes (mm <sup>2</sup> )	
		min	max
AFN 10	12	25	1200
AFN 20	24	35	1200
AFN 30	36	50	1000
AFN 36	42	70	1000

05/2017

## KIT CONTENTS

A kit always comprises 3 termination housings, water sealing sleeve, the installation instructions, special lubricant, wiper, earthing clamp, water sealing mastic, adhesive tape, field control mastic, ...

## ORDERING INSTRUCTIONS

Select the part number corresponding to both the system voltage and the cable dimensions in mm.

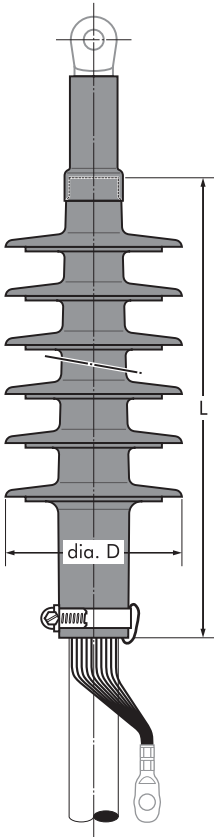

Cable lugs and earthing lugs are not included in the standard kit, but can be ordered separately.

Voltage Um (kV)	Conductor sizes (mm <sup>2</sup> )		Diameter over core insulation (mm)		Number of sheds	L (mm) (max)	Dia. D (mm)	Creepage distance (mm)	Ordering part number
	min	max	min	max					
12	25	95	12.7	21.0	3	210	90	369	3 x AFN 10-1
	120	240	19.0	28.5	3	210	96	365	3 x AFN 10-2
	300	500	27.0	37.0	3	210	105	360	3 x AFN 10-3
	630	800	34.0	46.0	4	240	118	462	3 x AFN 20-4
	1000		39.0	50.0	7	405	127	755	3 x AFN 36-5
	1200		46.0	58.0	7	405	127	755	3 x AFN 36-6
24	35	70	18.0	23.5	4	240	100	480	3 x AFN 20-1
	95	240	22.5	33.0	4	240	112	499	3 x AFN 20-2
	300	500	31.0	41.0	4	240	118	462	3 x AFN 20-3
	400	630	34.0	46.0	4	240	118	462	3 x AFN 20-4
	630	800	39.0	50.0	7	405	127	755	3 x AFN 36-5
	1000	1200	46.0	58.0	7	405	127	755	3 x AFN 36-6
36	50	70	23.5	29.0	6	300	115	695	3 x AFN 30-1
	95	240	27.0	38.0	6	300	115	694	3 x AFN 30-2
	240	400	32.0	43.0	6	300	127	718	3 x AFN 30-3
	400	630	39.0	50.0	7	405	127	755	3 x AFN 36-5
	630	1000	46.0	58.0	7	405	127	755	3 x AFN 36-6
42	70	120	28.0	32.0	7	405	127	755	3 x AFN 36-3
	150	300	31.5	41.0	7	405	127	755	3 x AFN 36-4
	400	630	39.0	50.0	7	405	127	755	3 x AFN 36-5
	630	1000	46.0	58.0	7	405	127	755	3 x AFN 36-6
For use in heavy polluted areas (terminations with an increased creepage length)									
42	70	120	28.0	32.0	11	535	127	1079	3 x AFNP 36-3
	150	300	31.5	41.0	11	535	127	1079	3 x AFNP 36-4
	400	630	39.0	50.0	11	535	127	1079	3 x AFNP 36-5
	630	1000	46.0	58.0	11	535	127	1079	3 x AFNP 36-6

### EXAMPLE:

A set of 3 outdoor terminations for a 24 kV - 240 mm<sup>2</sup> stranded aluminium cable with copper wire screen without cable lugs.

The diameter over core insulation

is 30.4 mm.

Order a 3 x AFN 20-2 termination kit.

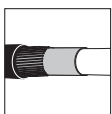

For use with copper wire screened cables. No earthing device is necessary.

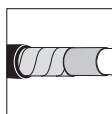

For use with copper tape screened cables. Order: -/MT.

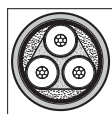

For use with three-core cables. Please contact our representative.



For use with other cable types. Please contact our representative.

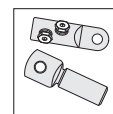

Can be supplied with all common types of cable lugs.



No heating or flame is required.

### APPLICATION

The T-ITK is a cold-shrinkable indoor termination suited for polymeric insulated three-core cables. It will provide a necessary seal against moisture penetration and a perfect electrical field control.

### DESIGN

Cold-shrinkable termination comprising:

1. Cable lugs (not included in the standard kit).
2. Water sealing mastic.
3. Silicone rubber tubes.
4. Stress control mastic.
5. Conductive EPDM ring.
6. Silicone rubber protection tubes.
7. Break-out.
8. Flexible finned copper braid (for use with individual metal tape screened cables).

### SPECIFICATIONS AND STANDARDS

The cold-shrinkable T-ITK termination meets the requirements of CENELEC HD 629.1.

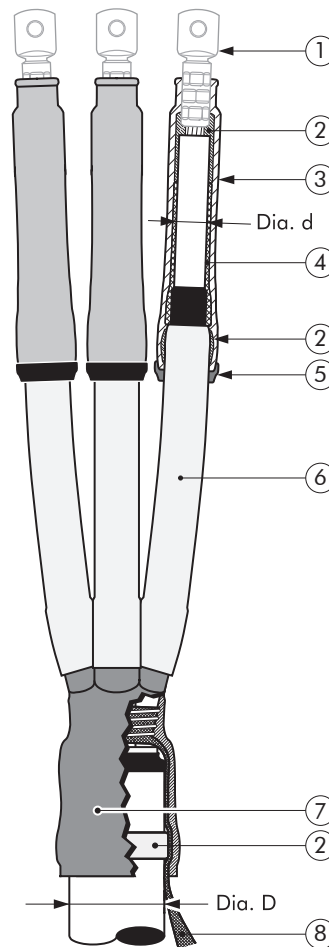

6/10 (12) kV  
6.35/11 (12) kV  
8.7/15 (17.5) kV  
12/20 (24) kV  
12.7/22 (24) kV

**Up to 24 kV**

Termination type	Voltage $U_m$ (kV)	Diameter over core insulation Dia. d (mm)		Diameter over outer sheath Dia. D (mm)		Conductor sizes (for information only) (mm <sup>2</sup> )	
		min	max	min	max	min	max
T-ITK 12-1	12	16	30	48	90	50	240
T-ITK 12-2	12	26	42	68	110	240	400
T-ITK 24-1	24	16	30	48	90	25	185
T-ITK 24-2	24	26	42	68	110	150	240

## KIT CONTENTS

The complete cold-shrinkable T-ITK termination kit comprises the following components:

The kit also comprises a roll of adhesive tape, flexible copper braid and installation instructions.

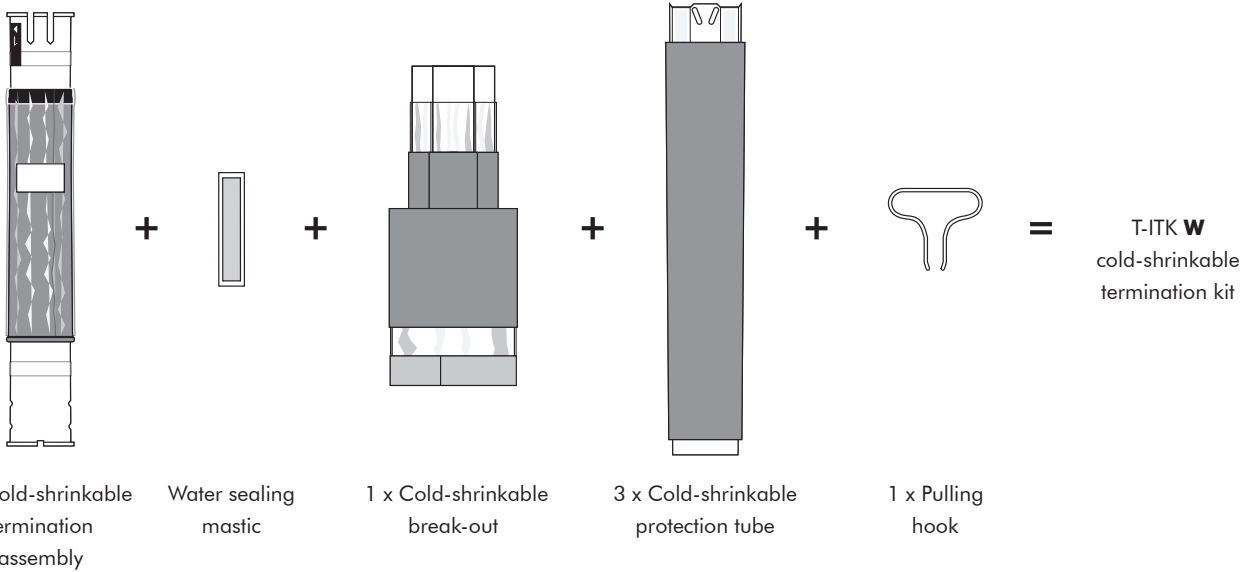

## ORDERING INSTRUCTIONS

Select the part number corresponding to both the system voltage and the cable dimensions in mm.

### EXAMPLE:

The cable is 12 kV, 3 x 150 mm<sup>2</sup> stranded aluminium, with a diameter of 72.0 mm over outer sheath and 23.5 mm over the core insulation. The cable has an individual copper tape screen. Order a T-ITK 12-1 termination kit.

Ordering part number	Voltage U <sub>m</sub> (kV)	Diameter over core insulation (mm)		Diameter over outer sheath (mm)	
		min	max	min	max
T-ITK 12-1	12	16	30	48	90
T-ITK 12-2	12	26	42	68	110
T-ITK 24-1	24	16	30	48	90
T-ITK 24-2	24	26	42	68	110

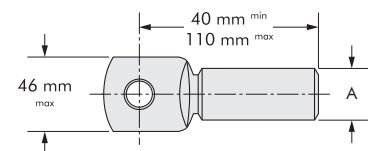

All commercialised European standard cable lugs can be used. Cable lugs should be within the dimensions specified (not applicable for ITK 312 and ITK 324).

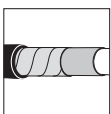

For use with copper tape screened cables. No further earthing device is necessary.

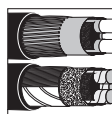

Different armour connections are available. Please contact our representative.

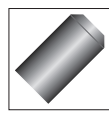

If the cable lug barrel diameter (A) is less than 20 mm: order a rubber adapting sleeve.

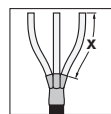

For tail lengths "X" between 500 and 700 mm.

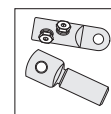

Can be supplied with all common types of cable lugs.

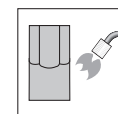

Also available with heat-shrinkable break-out

### APPLICATION

The T-OTK is a cold-shrinkable outdoor termination suited for polymeric insulated three-core cables. It will provide a necessary seal against moisture penetration and a perfect electrical field control.

### DESIGN

Cold-shrinkable termination comprising:

1. Cable lugs (not included in the standard kit).
2. Water sealing mastic.
3. Silicone rubber tubes with sheds.
4. Silicone rubber tubes.
5. Stress control mastic.
6. Conductive EPDM ring.
7. Silicone rubber protection tubes.
8. Break-out.
9. Flexible tinned copper braid (for use with individual metal tape screened cables).

### SPECIFICATIONS AND STANDARDS

The cold-shrinkable T-OTK termination meets the requirements of CENELEC HD 629.1.

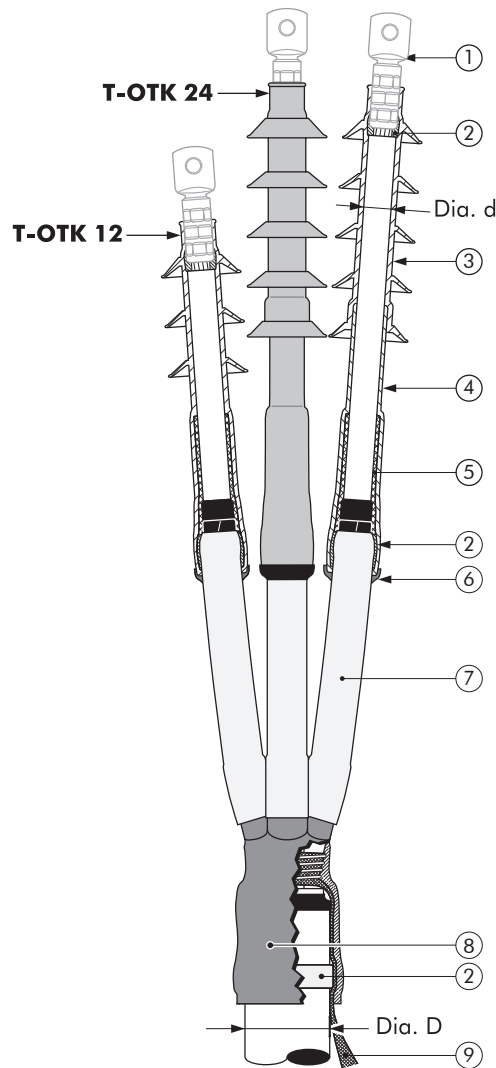

6/10 (12) kV  
6.35/11 (12) kV  
8.7/15 (17.5) kV  
12/20 (24) kV  
12.7/22 (24) kV

**Up to 24 kV**

Termination type	Voltage Um (kV)	Diameter over core insulation Dia. d (mm)		Diameter over outer sheath Dia. D (mm)		Conductor sizes (for information only) (mm <sup>2</sup> )	
		min	max	min	max	min	max
T-OTK 12-1	12	16	30	48	90	50	240
T-OTK 12-2	12	26	42	68	110	240	400
T-OTK 24-1	24	20	30	48	90	50	185
T-OTK 24-2	24	26	42	68	110	150	240

05/2017



## KIT CONTENTS

The complete cold-shrinkable T-OTK termination kit comprises the following components:

The kit also comprises a roll of adhesive tape, flexible copper braid and installation instructions.

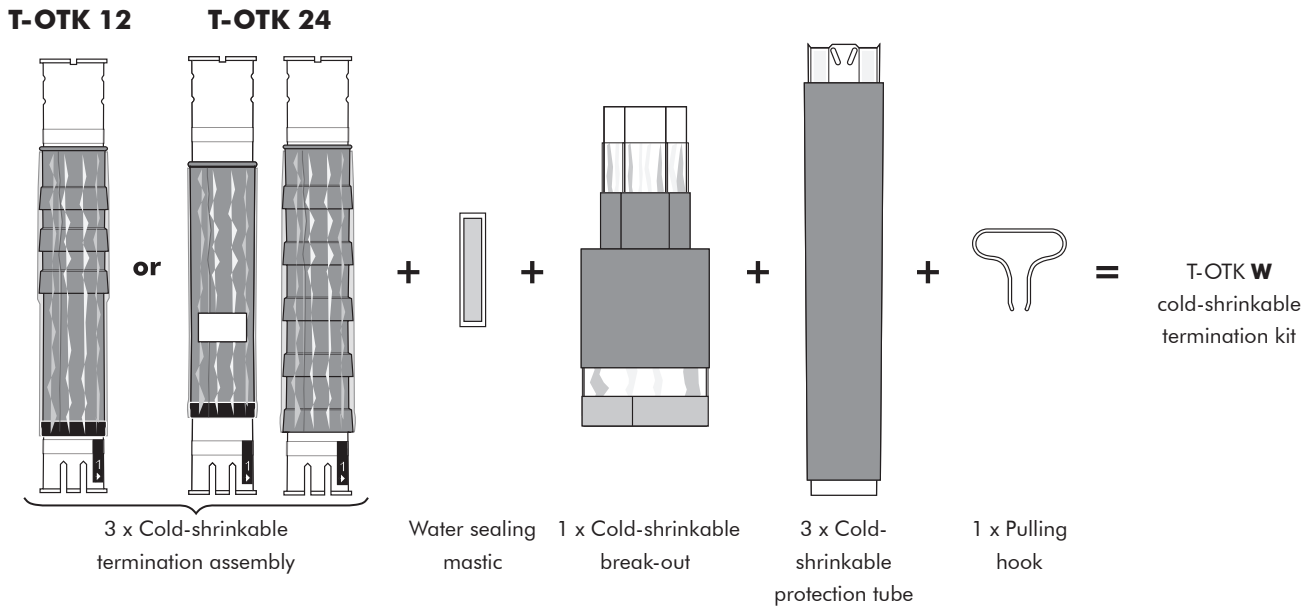

## ORDERING INSTRUCTIONS

Select the part number corresponding to both the system voltage and the cable dimensions in mm.

### EXAMPLE:

The cable is 12 kV, 3 x 150 mm<sup>2</sup> stranded aluminium, with a diameter of 72.0 mm over outer sheath and 23.5 mm over the core insulation. The cable has an individual copper tape screen. Order a T-OTK 12-1 termination kit.

Ordering part number	Voltage U <sub>m</sub> (kV)	Diameter over core insulation (mm)		Diameter over outer sheath (mm)	
		min	max	min	max
T-OTK 12-1	12	16	30	48	90
T-OTK 12-2	12	26	42	68	110
T-OTK 24-1	24	20	30	48	90
T-OTK 24-2	24	26	42	68	110

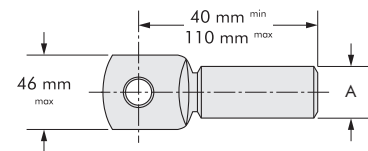

All commercialised European standard cable lugs can be used. Cable lugs should be within the dimensions specified.

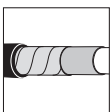

For use with copper tape screened cables. No further earthing device is necessary.

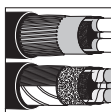

Different armour connections are available. Please contact our representative.



For use with other cable types. Please contact our representative.

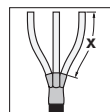

For tail lengths "X" between 650 and 850 mm.

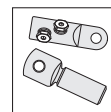

Can be supplied with all common types of cable lugs.

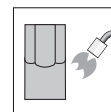

Also available with heat-shrinkable break-out

# 15TS-NSS

## UNIVERSAL BUSHING BOOT

### APPLICATION

This universal bushing boot is manufactured from non-tracking EPDM rubber and is designed to mate with all types of cold or heat-shrinkable terminations (without sheds). The bushing part fits interface diameters between 40 and 60 mm. The system is separable and allows easy removal for testing. This boot is suitable for all angles between 90° and 180°.



### KIT CONTENTS

The 3 x 15TS-NSS kit comprises 3 universal bushing boots, silicone grease and installation instructions.

6/10 (12) kV  
6.35/11 (12) kV  
8.7/15 (17.5) kV

**Up to 17.5 kV**

### CLEARANCES

This is an unscreened boot and therefore not safe to touch when energised. When used in a metal enclosed cable box, these minimum clearances must be respected.

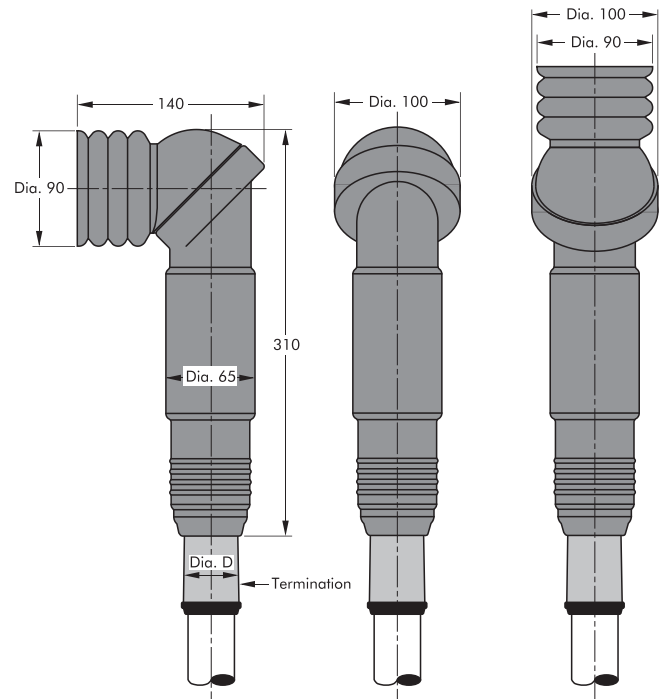
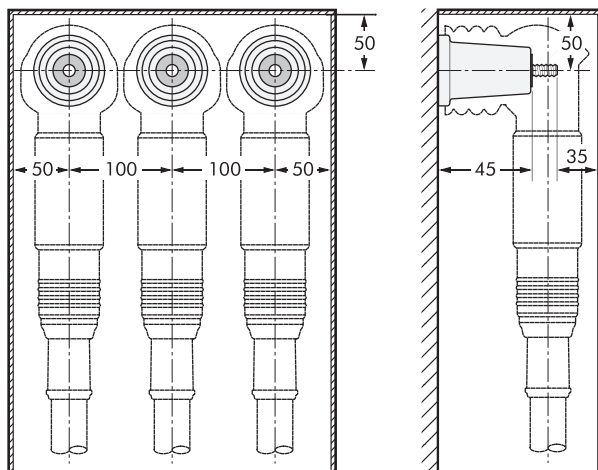

Bushing boot type	Voltage $U_m$ (kV)	Conductor sizes (mm <sup>2</sup> )		Diameter D over termination (mm)	
		min	max	min	max
15TS-NSS	17.5 max	35	630	20	50

In mm.

05/2017

# NOTES

---



# NOTES

---







Nexans Network Solutions N.V. - Div. Euromold  
Zuid III, Industrielaan 12, B-9320 Erembodegem  
Tel.: +32(0)53 85 02 11 • sales.euromold@nexans.com • www.euromold.be

Catalogue also available on Website and Mobile Apps



Find out more about Nexans Power Accessories.